



Installation & Operation Manual



Download
Manual



Growatt New Energy

Shenzhen Growatt New Energy Co., Ltd
4-13/F, Building A, Sino-German(Europe) Industrial Park,
Hangcheng Ave, Bao'an District, Shenzhen, China

T +86 755 2747 1942

E service@ginverter.com

W www.ginverter.com

GR-UM-249-A-01

Index

1 Notes on this manual

- 1.1 Validity
- 1.2 Applicable personnel
- 1.3 Symbols in this document

2 Safety

- 2.1 Product description and features
- 2.2 Qualification of skilled person
- 2.3 Safety instruction

3 Product overview

- 3.1 Appearance overview
- 3.2 Dimensions
- 3.3 Storage environment

4 Unpacking inspection

5 Installation

- 5.1 Basic installation requirements
- 5.2 Mounting wall mount
- 5.3 Installing the inverter

6 Inverter wiring

- 6.1 Security
- 6.2 AC side wiring
- 6.3 DC side wiring
- 6.4 Connect the signal cable
- 6.5 Grounding the inverter
- 6.6 Active power control with smart meter, CT or ripple control signal receiver
- 6.7 Inverter demand response modes (DRMS)
- 6.8 AFCI(Optional)

7 Debugging

8 Working mode

9 OLED display and touch buttons

10 Communication and monitoring

11 Maintenance and Cleaning

12 Start the inverter and shut down the inverter

- 8.1 Normal mode
- 8.2 Failure mode
- 8.3 Shutdown mode

- 9.1 Boot display
- 9.2 OLED display wake up
- 9.3 Function setting

- 10.1 RS485
- 10.2 USB-A

- 11.1 Checking heat dissipation
- 11.2 Cleaning the inverter
- 11.3 Checking the DC disconnect

- 12.1 Start the inverter
- 12.2 Shut down the inverter

13 Troubleshooting

14 Manufacturer warranty

15 Decommissioning

16 EU declaration of conformity

17 Specification

18 EU declaration of conformity

19 Contact us

- 13.1 Error message
- 13.2 System error

- 15.1 Dismantling the inverter
- 15.2 Packing the inverter
- 15.3 Storing the inverter
- 15.4 Disposing of the inverter

- 17.1 Specification
- 17.2 Torque
- 17.3 Annex

1 Notes on this manual

1.1 Validity

This manual will provide detailed product information and installation instructions for users of model TL3-X series photovoltaic inverter of Shenzhen Growatt new energy Co., Ltd. (hereinafter referred to as Growatt new energy). Please read this manual carefully before using this product. Growatt new energy will not inform users of any changes to this manual.

MID 17KTL3-X1 MID 17KTL3-X1-AU
 MID 20KTL3-X1 MID 20KTL3-X1-AU
 MID 22KTL3-X1 MID 22KTL3-X1-AU
 MID 25KTL3-X1 MID 25KTL3-X1-AU
 MID 30KTL3-X MID 30KTL3-X-AU
 MID 33KTL3-X MID 33KTL3-X-AU
 MID 36KTL3-X MID 36KTL3-X-AU
 MID 40KTL3-X MID 40KTL3-X-AU
 MID 10KTL3-X1-XL
 MID 12KTL3-X1-XL
 MID 15KTL3-X1-XL
 MID 17KTL3-X1-XL
 MID 20KTL3-X1-XL

1.2 Applicable personnel



The inverter must be installed by professional electricians who are certified by relevant departments. By reading this manual in detail, the installer can install the MID TL3-X series inverter correctly and quickly, and can carry out troubleshooting and communication system construction.



If there are any problems during the installation process, the installer can log on to www.growatt.com to leave a message on the website or call our 24-hour service phone:+86 755 2747 1942.

1.3 Symbols in this document











1.3.1 Symbols in this document

Warnings indicate hazards to equipment or personnel. It draws your attention to a certain procedure or practice. If the procedure or practice is not properly implemented or followed, it may cause damage or destruction of part or all of the Growatt device and/or other equipment connected to the Growatt device, or cause personal injury.

Symbol	Description
	DANGER indicates a hazardous situation which, if not avoided, will result in death or serious injury.
	WARNING indicates a hazardous situation which, if not avoided, could result in death or serious injury.
	CAUTION indicates a hazardous situation which, if not avoided, could result in minor or moderate injury.

	NOTICE is used to address practices not related to personal injury.
	Information that you must read and know to ensure optimal operation of the system.

1.3.2 Markings on this product

Symbol	Explanation
	Danger: Electricity!
	Danger:Flame!
	Danger:Hot surface!
	Operation after 5 minutes
	Point of connection for grounding protection
	Direct Current (DC)
	Alternating Current (AC)
	Read the manual
	CE mark. The inverter complies with the requirements of the applicable CE guidelines.
	The inverter must not be disposed of with the household waste.

1.3.3 Glossary

AC

Abbreviation for "Alternating Current"

DC

Abbreviation for "Direct Current"

Energy

Energy is measured in Wh (watt hours), kWh (kilowatt hours) or MWh (megawatt hours). The energy is the power calculated over time. For example, your inverter operates at a constant power of 4600 W for half an hour and then at a constant power of 2300 W for another half an hour, it has fed 3450Wh of energy into the power distribution grid within that hour.

Power

Power is measured in W (watts), kW (kilowatts) or MW (megawatts). Power is an instantaneous value. It displays the power your inverter is currently feeding into the power distribution grid.

Power rate

Power rate is the ratio of current power feeding into the power distribution grid and the maximum power of the inverter that can feed into the power distribution grid.

Power factor

Power factor is the ratio of active power or watts to apparent power or volt amps. They are identical only when current and voltage are in phase then the power factor is 1.0. The power in an ac circuit is very seldom equal to the direct product of the volts and amperes. In order to find the power of a single phase ac circuit the product of volts and amperes must be multiplied by the power factor.

PV

Abbreviation for photovoltaic.

Wireless communication

The external wireless communication technology is a radio technology that allows the inverter and other communication products to communicate with each other. The wireless communication device is not standard. Require to order extra if you need it.

2.1 Product description and features

2.1.1 Product description

Growatt series photovoltaic inverters are used to convert the direct current generated by photovoltaic panels into alternating current, and send it to the grid in a three-phase manner. MID 17-33KTL3-X(1)(AU) series inverter can be connected to six strings (MID 10-20KTL3-XL and MID 36-40KTL3-X(AU) can be connected to eight strings), has 3/4 maximum power tracking point trackers, so suitable for connection 3/4 Set of arrays of different panels.

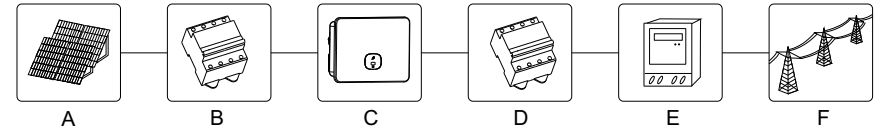

Fig 2.1

Position	Description
A	Solar panel
B	DC circuit breaker
C	Inverter
D	AC circuit breaker
E	Electric energy meter
F	Utility grid

As shown in Fig 2.1 above, a complete photovoltaic grid-connected system includes photovoltaic modules, photovoltaic inverters, public grids and other components. In the photovoltaic module system, the photovoltaic inverter is a key component.

Note: If the selected photovoltaic module requires positive or negative grounding, please contact Growatt for technical support before installation.

2.1.2 Product features

The characteristics of the inverter are as follows:

- > 3/4 independent maximum power point tracking
- > Built-in DC switch
- > Compatible with RS485/Wifi/GPRS/4G communication
- > 200V-1000V input voltage range
- > The maximum efficiency is as high as 98.8%
- > OLED+LED/WIFI+APP display
- > Integrated with touch button
- > Protection grade IP66
- > The weight is only 31kg
- > Simple installation



2.2 Qualification of skilled person

This grid-tied inverter system operates only when properly connected to the AC distribution network. Before connecting the MID TL3-X to the power distribution grid, contact the local power distribution grid company. This connection must be made only by qualified technical personnel to connect, and only after receiving appropriate approvals, as required by the local authority having jurisdiction.



2.3 Safety instructions

1. Please read this manual carefully before installation. If you fail to install according to the instructions in this manual, or ignore the warnings in the manual and the equipment is damaged, our company reserves the right not to guarantee the quality;
2. All operations and wiring should be finished by the professional electrical or mechanical engineers;
3. During installation, except for the wiring terminals, please do not move other parts inside the chassis;
4. All electrical installations must comply with local electrical safety standards;
5. If the machine needs maintenance, please contact the local designated system installation and maintenance personnel;
6. The use of this machine for grid-connected power generation requires permission from the local power supply department;
7. When installing photovoltaic modules during the day, use opaque materials to cover the photovoltaic modules, otherwise the voltage at the module terminals will be high in the sun, which may cause personal danger.



2.3.1 Assembly Warnings

 WARNING	<ul style="list-style-type: none"> ➤ Before installation, please check the unit to ensure that there is no transportation or handling damage, which may affect the insulation integrity or safety clearances; otherwise, it may cause safety hazards. ➤ Follow the instructions in this manual to assemble the inverter. Note that select the suitable mounting location and comply with the specified requirements of cooling. ➤ Unauthorized removal of necessary protections, improper use, incorrect installation and operation may lead to serious safety and shock hazards and/or equipment damage. ➤ In order to minimize the possibility of shock hazards due to dangerous voltages, cover the entire solar array with dark colored materials before connecting the array to any equipment.
 CAUTION	<ul style="list-style-type: none"> ➤ Grounding the PV modules: the MID TL3-X is a transformerless inverter, which means there is no galvanic separation. Do not ground the DC side of the MID TL3-X inverter. Only ground the mounting frame of the photovoltaic module. Otherwise there will be an error message "PV ISO Low". ➤ Comply with the local requirements for grounding the PV modules and the PV generator. GROWATT recommends connecting the generator frame and other electrically conductive surfaces in a manner which ensures continuous conduction with ground in order to have optimal protection of the system and personnel.

2.3.2 Electrical Connection Warnings

 DANGER	<ul style="list-style-type: none"> ➤ The components in the inverter are live. Touching live components can result in serious injury or death. <ul style="list-style-type: none"> • Do not open the inverter except the wire box by qualified persons. • Electrical installation, repairs and conversions may only be carried out by electrically qualified persons. • Forbid live line work. ➤ Danger to life due to high voltages in the inverter <ul style="list-style-type: none"> • There is residual voltage in the inverter after the device shutdown. The inverter need to take 20 minutes to discharge for safety. ➤ Persons with limited physical or mental abilities may only work with the Growatt inverter following proper instruction and under constant supervision. Must keep the Growatt inverter away from children.
 WARNING	<ul style="list-style-type: none"> ➤ Make all electrical connections (e.g. conductor termination, fuses, PE connection, etc.) in accordance with prevailing regulations. When using the inverter to provide the power, adhere to all prevailing safety regulations to minimize risk of accidents. ➤ Systems with inverters typically require additional control (e.g., switches, disconnects) or protective devices (e.g., fusing circuit breakers) depending upon the prevailing safety rules.

2.3.3 Operation Warnings

 WARNING	<ul style="list-style-type: none"> ➤ Ensure all connectors are sealed and secure during operation. ➤ Although designed to meet all safety requirements, some parts and surfaces of inverter are still hot during operation. To reduce the risk of injury, do not touch the heat sink at the back of the PV-inverter or nearby surfaces while inverter is operating. ➤ Incorrect sizing of the PV panels may result in voltages being present which could destroy the inverter. The inverter display will read the error message "PV Voltage High!"
 CAUTION	<ul style="list-style-type: none"> ➤ All operations regarding transport, installation and start-up, including maintenance must be operated by qualified, trained personnel and in compliance with all prevailing codes and regulations. ➤ When the inverter is disconnected from the grid, please be careful because some components can retain enough charge to create a shock hazard. In order to minimize the occurrence of this situation, observe all corresponding safety symbols and marks in this manual. ➤ Under special circumstances, the inverter may be subject to electromagnetic interference from surrounding equipment. At this time, the user is obliged to take correct measures to reduce the interference from surrounding equipment to the inverter. ➤ Do not stay close to the inverter less than 20cm at any time.

3.1 Appearance overview

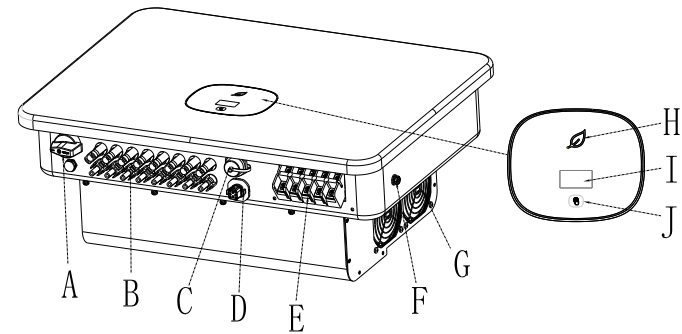



Fig 3.1

The appearance instructions are as follows:

No.	Name	No.	Name
A	DC switch	F	PE terminal
B	PV terminal	G	Fan
C	USB port	H	OLED indicator
D	RS485 port	I	LCD screen
E	AC terminal	J	Touch button

Caution: MID17-40KTL3-X(1)-AU without DC switch.

The label description on the inverter:

LOGO	Description	Description
	Tap logo	Touch button: We can switch the LED display and set parameters by touching.
	Inverter status identification	Indicate the current running status of the inverter Red: fault Green: normal operation Flashing red light: warning Flashing green: update program

3.2 Dimensions

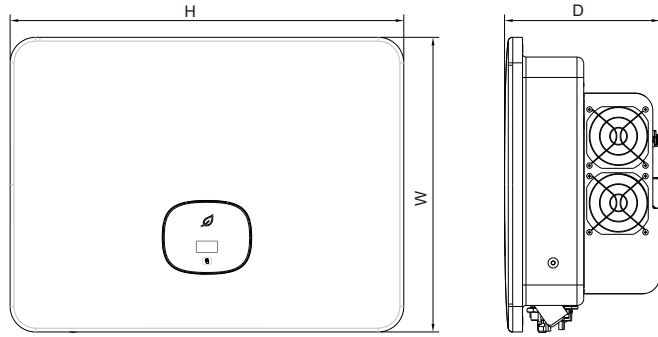

Fig 3.2

Size and weight:

Model	Height (H)	Width (W)	Depth (D)	Weight
MID 17-33KTL3-X(1)(AU)	580mm	430mm	230mm	30kg
MID 10-20KTL3-XL/ MID 36-40KTL3-X(AU)	580mm	430mm	230mm	31kg

3.3 Storage Environment

If you want to store the inverter in a warehouse, you must choose a suitable location for the inverter.

- > The equipment must be stored in its original packaging.
- > The storage temperature should always be between -25°C and +60°C, and the storage relative humidity should be less than 90%.
- > If you need to store a batch of inverters, the maximum number of layers of the original carton is 4.

Unpacking inspection 4

Before opening the inverter package, please check whether the outer package is damaged. After unpacking, please check whether the appearance of the inverter is damaged or lack of accessories. If there is damage or missing parts, please contact the dealer.

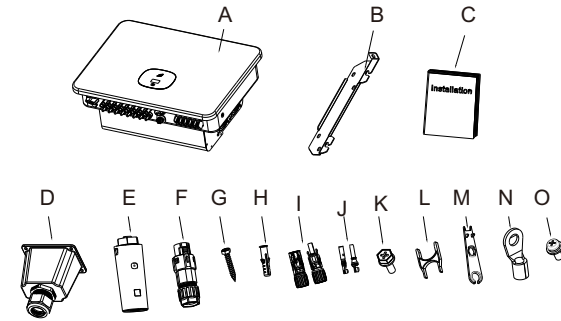

Fig 4.1

No.	Description	Qty.
A	Inverter	1
B	Wall mount	1
C	Quick Installation Manual	1
D	AC waterproof cover(just for Vietnam models)	1
E	Datalogger	1
F	COM port signal connector	1
G	Expansion screw	4
H	Plastic expansion tube	4
I	PV terminal shell	6/6(8/8)
J	PV terminal core	6/6(8/8)
K	Security screw	1
L	COM port removal tool	1
M	PV terminal removal tool	1
N	14-6 O terminal	6
O	Fixed AC side water proof cover M4*10 screw	4

Note:

PV+/ PV-terminal and PV+/ PV-metal terminal have 6/6PCS for MID 17-33KTL3-X(1)(AU);

PV+/ PV-terminal and PV+/ PV-metal terminal have 8/8PCS for MID 10-20KTL3-XL and MID 36-40KTL3-X(AU).

5 Installation

5.1 Basic installation requirements

- > The wall on which the inverter is mounted must be sturdy and can withstand the weight of the inverter for a long time (refer to the specifications in Chapter 12 for the weight of the inverter);
- > The installation location must match the size of the inverter;
- > Do not install the inverter on a building constructed of flammable or heat-resistant materials;
- > Install the inverter in an eye-view orientation to facilitate inspection of the OLED display and maintenance work;
- > The machine's degree of protection is IP66 and can be installed indoors and outdoors;
- > It is not recommended to expose the inverter directly to strong sunlight to prevent overheating and cause power derating;
- > The humidity of the installation environment should be between 0 and 90%;
- > The ambient temperature around the inverter should be between $-25^{\circ}\text{C} \sim 60^{\circ}\text{C}$;
- > The inverter can be mounted on a plane that is tilted vertically or backwards. Please refer to the following figure:

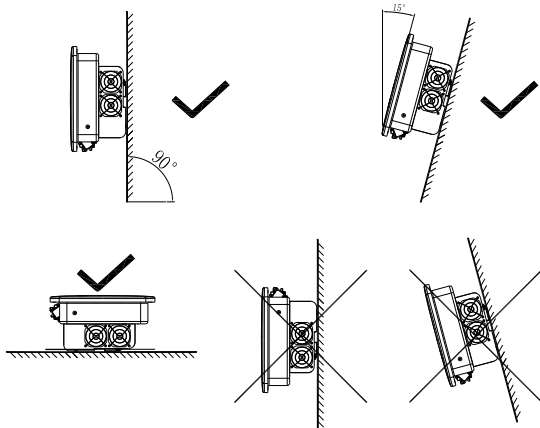

Fig 5.1 Installation diagram

- > In order to ensure the normal operation of the machine and the convenience of personnel operation, please pay attention to provide sufficient clearance for the inverter. Please refer to the figure below:

Direction	Minimum clearance (mm)
Above	300
Under	500
Both sides	500
Forward	300

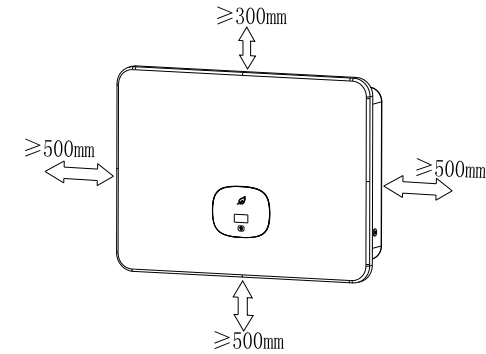

Fig 5.2 Installation dimensions for one inverter

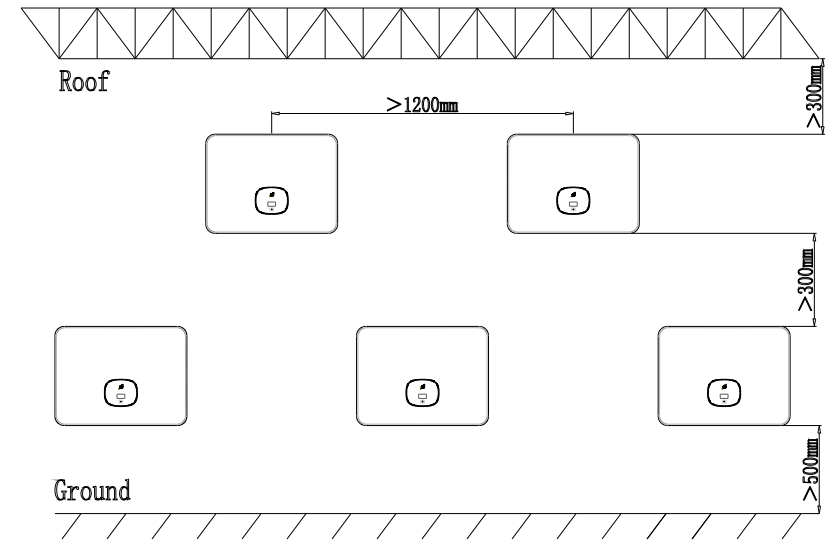

Fig 5.3 Installation dimensions for multiple inverters

- > Do not install the inverter on the TV antenna, other antennas or antenna cables;
- > Do not install the inverter in the living area;
- > Do not install the inverter where children can reach it;
- > The inverter should be installed in a sheltered and protected location such as cool, rain-proof;

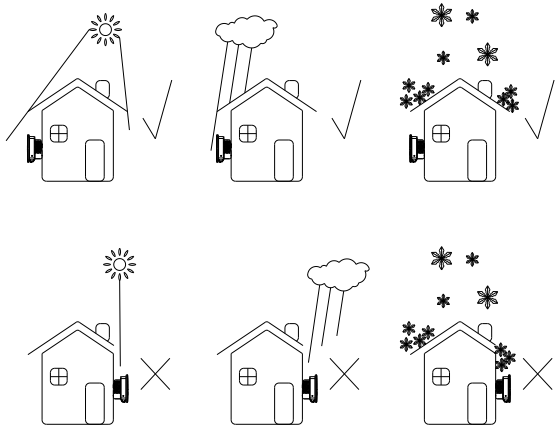

Fig 5.4 Installation Environment

- Make sure that the inverter is installed in a suitable place and is not allowed to be installed in a closed box;

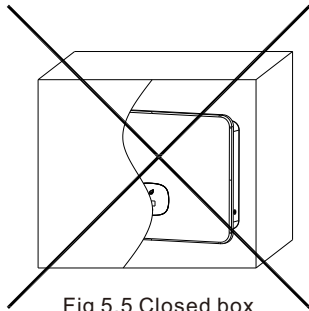

Fig 5.5 Closed box

- In order to reduce the inverter load and extend the life of the inverter due to direct sunlight, we recommend installing a awning. The distance between the awning and the inverter is as follows:

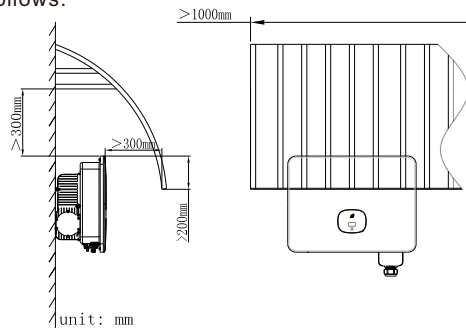

Fig 5.6 Sunshade

5.2 Install the wall mount

5.2.1 Install the wall mount

 Danger	<p>To prevent electric shock or other damage, be sure to check the wall for power or other piping before opening the hole in the wall.</p>
-------------------	--

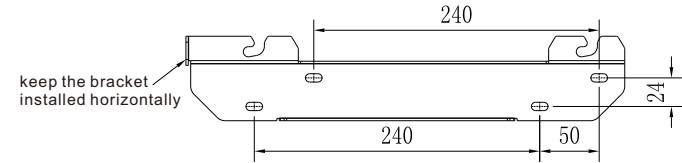

Fig 5.7 Specifications of wall mount

- Secure the wall mount as shown, do not let the screws flush with the wall, instead expose 2 to 4 mm.

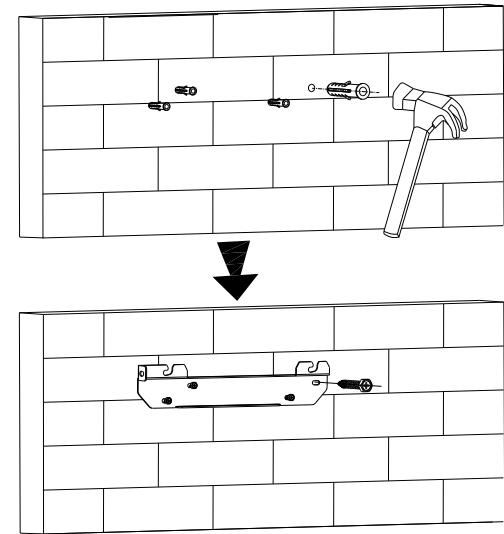

Fig 5.8 Schematic diagram of wall mount installation

5.3 Installing the inverter

Note: Before installing the inverter, you must first make sure that the wall mount is firmly fixed to the wall.

steps:

1. Hang the inverter on the wall mount and keep the inverter balanced when hanging.
2. To ensure that the inverter can be securely attached to the wall, secure the side of the inverter with the M5 safety screw on the left.

Inverter wiring 6

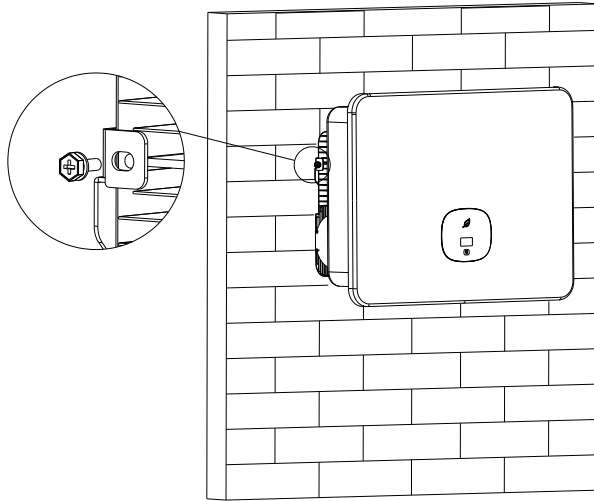







Fig 5.9 Schematic diagram of inverter wall mounting

6.1 Security

 Danger	<p>There may be a high voltage in the conductive part of the inverter, which may cause electric shock. Therefore, when installing the inverter, make sure that the AC and DC sides of the inverter are powered off.</p>
 Warning	<p>Static electricity may damage the electronic components of the inverter. Anti-static measures should be taken during the replacement or installation of the inverter.</p>
 Note	<p>Moisture and dust penetration can damage the inverter</p> <ul style="list-style-type: none"> > Make sure that the waterproof cable gland is firmly tightened. > If the cable connector is not installed correctly, the inverter may be damaged due to the penetration of moisture and dust. All warranty claims are void

6.2 AC side wiring

 Danger	<p>Before making electrical connections, please make sure that the DC switch of the inverter is in the "OFF" state and disconnect the AC side MCB, otherwise the high voltage of the inverter may cause death.</p>
 Warning	<ul style="list-style-type: none"> > Each inverter must be installed with an AC circuit breaker independently, and it is forbidden to share multiple inverters. > It is forbidden to use single-core wire at the output terminal of the inverter. > It is forbidden to use aluminum wires as output cables. > Please ensure that the output cable is well connected before turning on the inverter. Ignoring the above warning may damage the machine or cause other losses. In this case, the company reserves the right not to carry out the warranty and bear any responsibility and related expenses.
 Note	<p>Moisture and dust penetration can damage the inverter.</p> <ul style="list-style-type: none"> > Make sure the cable connector is securely tightened. > If the cable connector is not installed correctly, the inverter may be damaged by moisture and dust. All warranty claims are invalid.

Residual current protection device (RCMU)

Because the inverter itself has a high-precision residual current detection device, it is not recommended to install a leakage protection switch in the system. If for some special reason, it must be installed between the inverter output and the grid. Please install a type B leakage protection switch above 300mA. When multiple leakage protection switches are installed in the system, it is forbidden to share the neutral line, otherwise the leakage protection function may be triggered by mistake and cause the switch to trip.

Preparation before wiring :

Connect the protective ground wire (PE)
Connect the inverter to the grounding bar through the protective earth (PE) to achieve grounding protection.

	<ul style="list-style-type: none"> > Good grounding is good for resisting surge voltage impact and improving EMI performance. Therefore, you need to ground the wire before connecting the AC, DC, and communication cables. > For a single-machine system, only the PE cable needs to be grounded; For a multi-machine system, the PE cables of all inverters need to be connected to the same grounding copper bar to ensure equipotential connection.
---	--

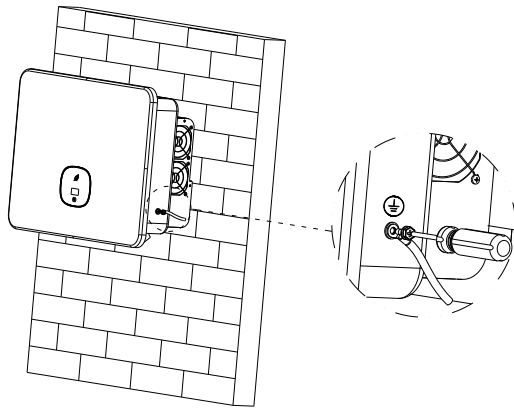

Fig 6.1 Grounding diagram

- > Disconnect the inverter DC switch, AC side circuit breaker or switch.
- > Measure the voltage and frequency of the public grid (voltage: AC 230V; frequency: 50Hz)

The recommended specifications of the AC output switch are as follows:

Inverter model	Switch specification
MID 17KTL3-X1(AU)	40A/230V
MID 20KTL3-X1(AU)	40A/230V
MID 22KTL3-X1(AU)	50A/230V
MID 25KTL3-X1(AU)	50A/230V
MID 30KTL3-X(AU)	80A/230V
MID 33KTL3-X(AU)	80A/230V
MID 36KTL3-X(AU)	100A/230V
MID 40KTL3-X(AU)	100A/230V
MID 10KTL3-XL1	40A/127V

Inverter model	Switch specification
MID 12KTL3-XL1	50A/127V
MID 15KTL3-XL	50A/127V
MID 17KTL3-XL	80A/127V
MID 20KTL3-XL	80A/127V

AC connection steps (just for Vietnam models):

1. Pass the 5 wires (L1, L2, L3, N and PE wires) through the AC shield, connect them to the power grid, and then crimp the O/U terminal.

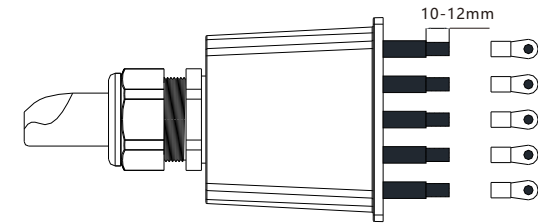

Fig 6.2

2. Lock the AC cable to the corresponding AC terminal.

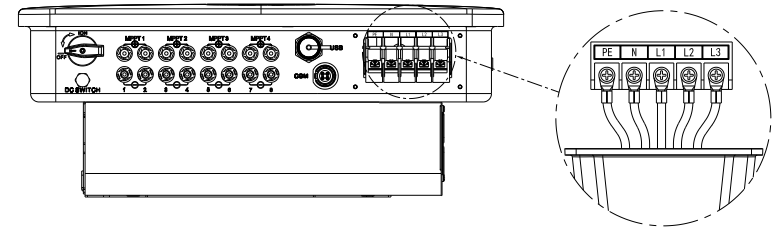

Fig 6.3

3. Lock the protective cover on the inverter frame, and finally tighten the protective cover hole.

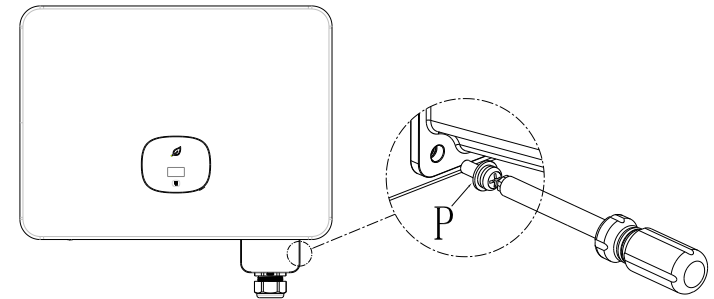



Fig 6.4

Noted: Waterproof must be blocked with fireproof mud to prevent water.

Suggested line length:

Inverter model	Cross-section area	Recommendation	Maximum Wire Length
MID 17KTL3-X1(AU)	10-16	10	40
MID 20KTL3-X1(AU)	10-16	10	40
MID 22KTL3-X1(AU)	10-16	10	40
MID 25KTL3-X1(AU)	10-16	10	40
MID 30KTL3-X(AU)	10-16	16	40
MID 33KTL3-X(AU)	10-16	16	30
MID 36KTL3-X(AU)	14-20	16	30
MID 40KTL3-X(AU)	14-20	16	30
MID 10KTL3-XL1	14-20	16	30
MID 12KTL3-XL1	14-20	16	30
MID 15KTL3-XL	14-20	16	30
MID 17KTL3-XL	14-20	16	30
MID 20KTL3-XL	14-20	16	30

6.3 DC side wiring

 Danger	<ul style="list-style-type: none"> > Sunlight will generate voltage on the battery panel. The high voltage after the series connection may cause life danger. Therefore, before connecting the DC input cable, you need to cover the battery panel with an opaque material before operation, and ensure the reverse The DC switch of the inverter is in the "OFF" state, otherwise the high voltage of the inverter may cause life danger. > To avoid electric shock, do not touch the live parts, and connect the terminals carefully. > Please make sure that the AC switch has been disconnected before wiring.
 Warning	<p>Please ensure that the following conditions are met, otherwise it may cause a fire hazard or damage the inverter. In this case, the company does not carry out quality assurance and assumes any responsibility.</p> <ul style="list-style-type: none"> > The maximum open circuit voltage of each string of photovoltaic modules shall not exceed 1100Vdc under any conditions. > PV modules connected in series in each PV string are of the same specification type. > The maximum short-circuit current of each PV string must not exceed 26A under any conditions. > The total output power of all PV strings must not exceed the maximum input power of the inverter. > In order to optimize the system configuration, it is recommended to connect the two inputs with the same number of photovoltaic modules. > If the inverter output is directly connected to the grid (that is, the output side is not connected to a low-frequency isolation transformer), please ensure that the PV string is not grounded. > if at the inverter inputs is connected a specific type of thin-film battery module (PV-grounded), please connect the low-frequency isolation transformer to the output terminal before turning it on, otherwise the inverter will be damaged.

 Note	<ul style="list-style-type: none"> > If a stable non-zero DC voltage is measured between the positive pole of the photovoltaic string and the ground, it means that an insulation fault has occurred at a certain position in the photovoltaic string. You need to ensure that the fault is repaired before continuing the wiring. <p>Moisture and dust penetration can damage the inverter</p> <ul style="list-style-type: none"> > Make sure that the waterproof cable gland is firmly tightened. > If the cable connector is not installed correctly, the inverter may be damaged due to the penetration of moisture and dust. All warranty claims are void.
--	---

The MID series inverter has two independent inputs, as shown in the figure below:

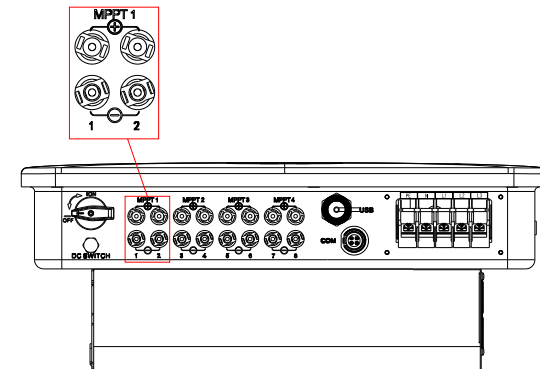



Fig 6.5

Note: MID 17-33KTL3-X(1)(AU) (3-channel string); MID 10-20KTL3-XL and MID 36-40K TL3-X(AU)(4-channel string) .

The following points should be concerned when choosing photovoltaic modules:

- > The photovoltaic modules of each photovoltaic string are of the same specification and model.
- > The photovoltaic modules of each photovoltaic string are connected in series with the same number.

 Note	<ul style="list-style-type: none"> > Before connecting the battery panel, please make sure that the DC input polarity is correct, that is, the positive pole of the photovoltaic module is connected to the DC input terminal marked "+" of the inverter, and the negative pole is connected to the DC input terminal marked "-". > The maximum DC input current and voltage of the inverter shall not exceed the following limits. 												
	<table border="1"> <thead> <tr> <th>Model</th> <th>Single maximum input current</th> <th>Maximum input voltage</th> </tr> </thead> <tbody> <tr> <td>MID 17-33KTL3-X(1)(AU)</td> <td>26A</td> <td>1100V</td> </tr> <tr> <td>MID 36-40KTL3-X(AU)</td> <td>26A</td> <td>1100V</td> </tr> <tr> <td>MID 10-20KTL3-XL</td> <td>26A</td> <td>1100V</td> </tr> </tbody> </table>	Model	Single maximum input current	Maximum input voltage	MID 17-33KTL3-X(1)(AU)	26A	1100V	MID 36-40KTL3-X(AU)	26A	1100V	MID 10-20KTL3-XL	26A	1100V
Model	Single maximum input current	Maximum input voltage											
MID 17-33KTL3-X(1)(AU)	26A	1100V											
MID 36-40KTL3-X(AU)	26A	1100V											
MID 10-20KTL3-XL	26A	1100V											

Connect DC terminal

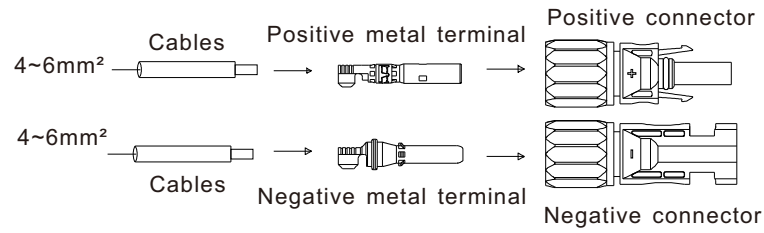

Fig 6.7

6.4 Connect the signal cable

The MID series inverter has an 16-Pin signal connector except Vietnam models. The client signal line port is as follows:

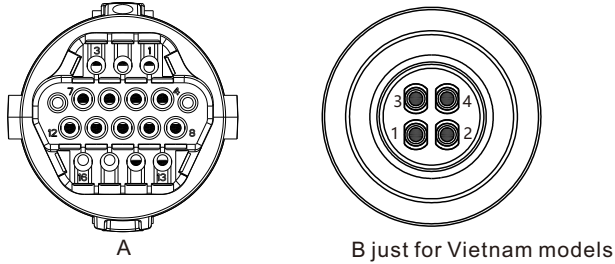

Fig 6.8

1.Strip the cable 10mm through the waterproof gland, thread sleeve, and tighten the screws.

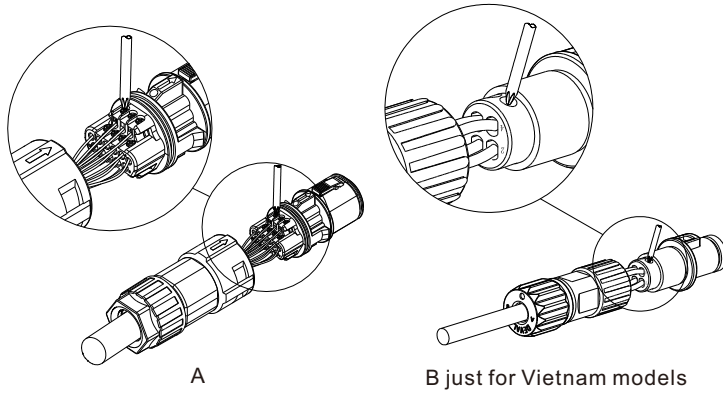

Fig 6.9

2.Push the threaded sleeve into the socket and tighten the waterproof gland.

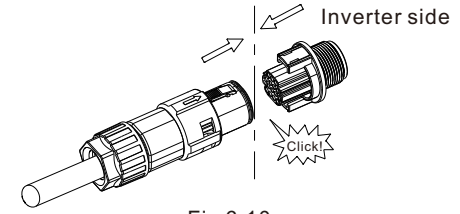

Fig 6.10

3.Connect the client to the inverter plug until both are tightly locked on the inverter.

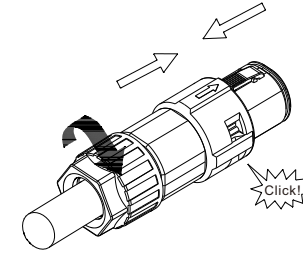

Fig 6.11

Remove the signal connector

1.Press down the fastener and pull it out of the inverter.

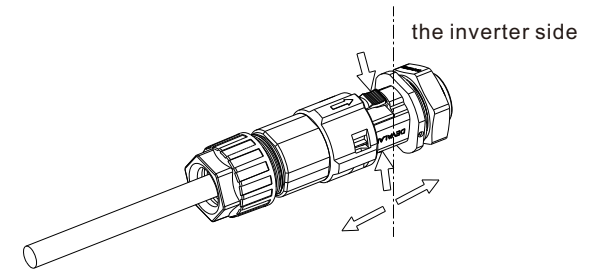

Fig 6.12

2. Insert the H-shaped tool and pull it out of the socket.

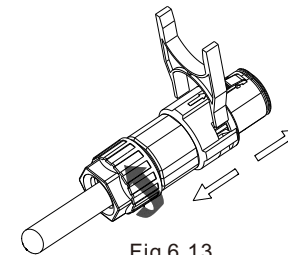



Fig 6.13

6.5 Grounding the inverter

The inverter must be connected to the AC grounding conductor of the power distribution grid via the ground terminal (PE).

 WARNING	<p>Because of the transformerless design, the DC positive pole and DC negative pole of PV arrays are not permitted to be grounded.</p>
--	--

According to the relevant provisions of IEC 61643-32 "Connecting to photovoltaic devices surge protectors - selection and use of guidelines", whether for household or commercial photovoltaic power plants, it is necessary to ensure the implementation of lightning protection measures for photovoltaic systems.

 WARNING	<p>The lightning protection measures for photovoltaic systems shall be carried out in accordance with the corresponding national standards and IEC standards. Otherwise, photovoltaic devices such as components, inverters and power distribution facilities may be damaged by lightning. In this case, the company does not carry out warranty and assumes any responsibility.</p>
--	--

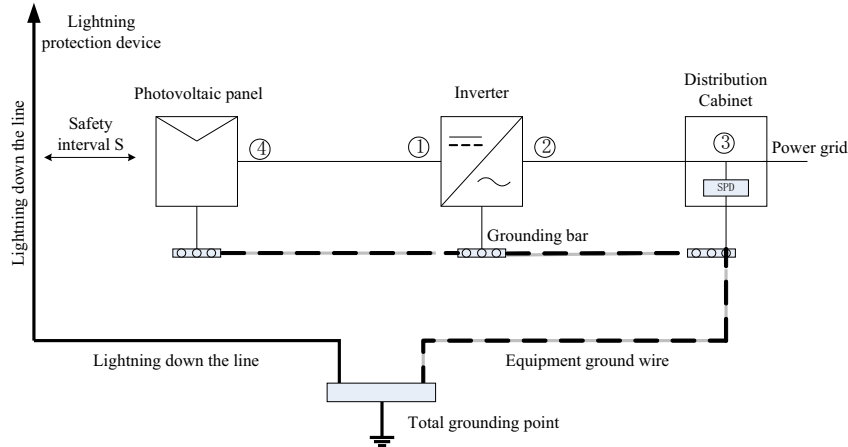

Fig 6.14

- 1) It is generally recommended to install lightning protection devices (such as lightning rods / lightning protection belts and down conductors) to prevent lightning from hitting the PV array.
- 2) Lightning protection devices and down-conductors and related equipment in photovoltaic systems (including photovoltaic panels, inverters, cables, power distribution equipment) should maintain a safe separation distance S. Suggested value of S: According to the general 5 storey height (about 15m) building roof, S takes 2.5m enough, this distance can be simplified according to the inverse relationship of the floor height.

A. When the safety distance S is satisfied:

The position ①③ of the figure should be equipped with a lightning protection module. In general, it is recommended to install Type II in position ① and Type I in position ③.

B. When the safety and safety distance S is not met:

In addition to position 3, Type I lightning protection module should be installed in Figure ①②④.

3) The lightning down conductor and the equipment ground wire eventually sink at a total ground point, but the two cannot share the wire. That is, the equipment grounding wire should be pulled separately, and the wire diameter requirement $>6\text{mm}^2$ when the safety interval distance S is satisfied.

4) About the above lightning protection lightning receptor system related design reference GB/T 21714.3-2015.

6.6 Active power control with smart meter , CT or ripple control signal receiver

 Information	<p>The position of export limitation CT or Meter must between the Inverter & Load and grid. Multiple inverter combination is not suitable in Australia.</p>
---	---

This series inverter has integrated export limitation functionality. To use this function, you can connect smart meter or CT. The primary aperture is 10mm,output cable length is 5m . The arrow on the CT must pointing towards the inverter.

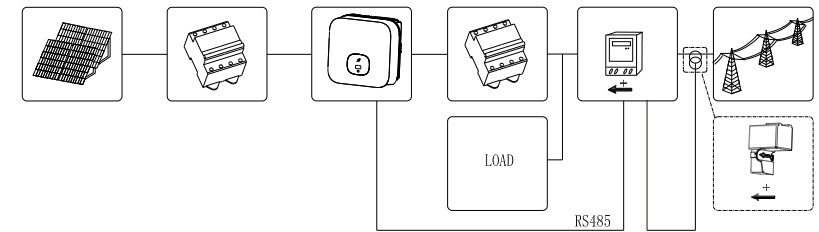

Fig 6.15

Manufacturer	Eastron
Type	SDM630CT-Modbus V3
General Specifications	
Voltage AC (Un)	3*230V
Voltage Range	184~299V AC
Base Current (Ib)	10A
Power consumption	≤2W
Frequency	50/ 60Hz(±10%)

AC voltage withstand	4KV for 1 minute
Impulse voltage withstand	6KV-1.2uS waveform
Overcurrent withstand	20I _{max} for 0.5s
Pulse output 1	1000imp/kWh (default)
Pulse output 2	400imp/kWh
Display Max. Reading	LCD with white backlit 999999kWh
Environment	
Operating temperature	-25°C to +55°C
Storage and transportation temperature	-40°C to +70°C
Reference temperature	23°C ±2°C
Relative humidity	0 to 95%, non-condensing
Altitude	up to 2000m
Warm up time	3s
Installation category	CAT II
Mechanical Environment	M1
Electromagnetic environment	E2
Degree of pollution	2
Mechanics	
Din rail dimensions	72x66x100 (WxHxD) DIN 43880
Mounting	DIN rail 35mm
Ingress protection	IP51 (indoor)
Material	self-extinguishing UL94V-0

Active power control with a Radio Ripple Control Receiver(RRCR).

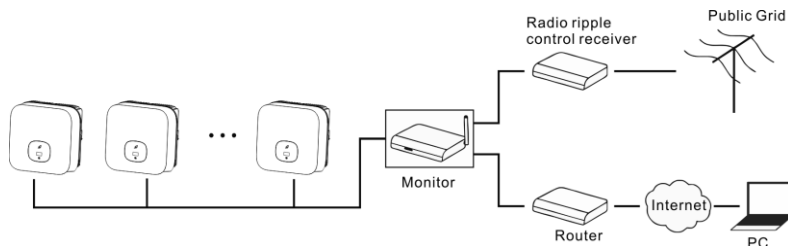





Fig 6.16

6.7 Inverter demand response modes (DRMS)

This series inverter has the function of demand response modes, We use 16-Pin socket as inverter DRMS connection.

 Information	<p>DRMS application description</p> <ul style="list-style-type: none"> ➤ Applicable to AS/NZS4777.2:2015 or Commission Regulation (EU) 2016/631. ➤ DRM0, DRM5, DRM6, DRM7, DRM8 are available.
 CAUTION	<p>Damage to the inverter due to moisture and dust penetration</p> <ul style="list-style-type: none"> ➤ Make sure the cable gland has been tightened firmly. ➤ If the cable gland are not mounted properly, the inverter can be destroyed due to moisture and dust penetration. All the warranty claim will be invalid.
 WARNING	<p>Excessive voltage can damage the inverter! External voltage of DRM PORT don't over +5V.</p>

6.7.1 16-Pin socket pin assignment

Pin No.	Assignment for inverters capable of both charging and discharging
9	DRM 5
10	DRM 6
11	DRM 7
12	DRM 8
13	RefGen
14	Com/DRM0
15	NC
16	NC

6.7.2 Method of asserting demand response modes

Mode	Socket asserted by shorting pins		Function
DRM 0	14	13	Operate the disconnection device.
DRM 5	9	13	Do not generate power.
DRM 6	10	13	Do not generate at more than 50% of rated power.
DRM 7	11	13	Do not generate at more than 75% of rated power and reduce the reactive power as far as possible.
DRM 8	12	13	Increase power generation (subject to constraints from other active DRMs).

6.7.3 Using the Power Control Interface for EU

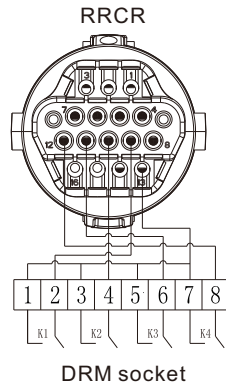

Fig 6.17 Inverter – RRCR Connection

6.7.3.1 The following table describes the connector pin assignment and function:

DRM Socket Pin NO.	Description	Connect to RRCR
9	Relay contact 1 input	K1 – Relay 1 output
10	Relay contact 2 input	K2 – Relay 2 output
11	Relay contact 3 input	K3 – Relay 3 output
12	Relay contact 4 input	K4 – Relay 4 output
13	GND	Relays common node
14	Not connected	Not connected
15	Not connected	Not connected
16	Not connected	Not connected

6.8.3.2 The inverter is preconfigured to the following RRCR power levels:

DRM Socket Pin 9	DRM Socket Pin 10	DRM Socket Pin 11	DRM Socket Pin 12	Active power	Cos(φ)
Short circuit with Pin 13				0%	1
	Short circuit with Pin 13			30%	1
		Short circuit with Pin 13		60%	1
			Short circuit with Pin 13	100%	1

Active power control and reactive power control are enabled separately.

6.8 AFCI(Optional)

6.8.1 Arc-Fault Circuit Interrupter (AFCI)

In accordance with the National Electrical Code R, Article 690.11, the inverter has a system for the recognition of electric arc detection and interruption. An electric arc with a power of 300 W or greater must be interrupted by the AFCI within the time specified by UL 1699B. A tripped AFCI can only be reset manually. You can deactivate the automatic arc fault detection and interruption (AFCI) via a communication product in "Installer" mode if you do not require the function. The 2011 edition of the National Electrical Code R, Section 690.11 stipulates that newly installed PV systems attached to a building must be fitted with a means of detecting and disconnecting serial electric arcs (AFCI) on the PV side.

6.8.2 Danger information

	<p>Danger of fire from electric arc Only test the AFCI for false tripping in the order described below. Do not deactivate the AFCI permanently.</p>
--	---

If an "Error 200" message is displayed, the buzzer alarms, an electric arc occurred in the PV system. The AFCI has tripped and the inverter is in permanent shutdown. The inverter has large electrical potential differences between its conductors. Arc flashes can occur through air when high-voltage current flows. Do not work on the product during operation. When the inverter error 200, please follow the steps:

6.8.3 Operation step

6.8.3.1 Turn the DC & AC Switch to position "OFF".

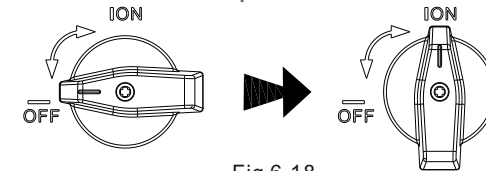

Fig 6.18

Wait for the screen be off.

6.8.3.2 Perform troubleshooting on the PV system:

Check the PV strings' open circuit voltage is normal or not.

6.8.3.3 After the fault is rectified, restart the inverter:

Turn the DC & AC Switch to position "ON".

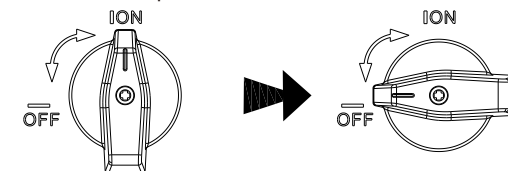

Fig 6.19

6.8.4 Earth Fault Alarm

The inverter complies with AS/NZS 5033. When the Earth fault occurs, the Red LED will light up. The buzzer in the inverter will keep ringing unless the fault condition is cleared (This function is only available for Australia and New Zealand).

• If there is PV isolation low alarm, there might be some fault for the inverter case ground protection, please do not touch the inverter case.

7 Debugging

1. Close the DC switch on the inverter. As long as the input DC voltage is greater than 140V, the inverter display will show the following information: No mains connection error, the inverter LED will turn red.

If other information is displayed, please refer to Chapter 13. If you encounter any problems during the debugging process and cannot solve it, please contact customer service.

2. Close the circuit breaker or switch between the inverter and the grid, the inverter will start a countdown to the self-check, and after the self-check is normal, it will be connected to the grid.

3. In normal operation, the leaves of the inverter indicator window will turn green.

4. Finish debugging.

8.1 Normal mode

In this mode, the inverter works normally.

- When the DC voltage is greater than 250V, the energy is sufficient, and the grid voltage frequency meets the grid-connected requirements, the inverter will convert the energy of the solar panels into AC power and export to the grid, and the green LED will light up.
- When the DC voltage is lower than 180V, the inverter will automatically disconnect from the grid and exit the normal operation mode. When the input voltage reaches the requirement again and the grid voltage and frequency return to normal, the inverter will automatically connect to the grid.

8.2 Failure mode

The inverter controls the chip monitors and adjusts the state of the system in real time. When the inverter monitors any unexpected conditions, such as system failure and inverter failure, the display will show the fault information. In the failure mode, the inverter will indicate The leaves of the window will turn red and the inverter output will be disconnected from the grid.

8.3 Shutdown mode

When the sunlight is weak or there is no sunlight, the inverter will automatically stop running. When in shutdown mode, the inverter basically does not consume energy from the grid or solar panels, and at the same time, the inverter's display screen and LED lights will be turned off.

9 OLED display and touch button

The OLED display can display the running status of the inverter, as well as various parameters information, and the display interface of the inverter can be switched and the inverter parameters can be set by touching the button.

Mark	Describe	Explain	
	Touch mark	Single touch	Switch the display interface or the current number plus 1
		Double touch	Enter the setting state or confirm
		Triple touch	Return to the previous display interface
		Long press for 5s	The current data returns to the default value

9.1 Boot display

When the inverter is turned on, the OLED display interface is as follows:

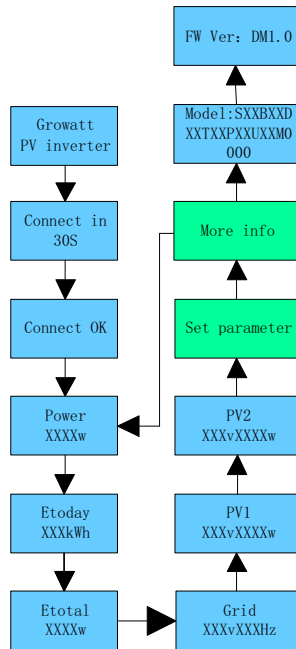

Fig 9.1

9.2 OLED display wake up

After the inverter works normally for 5 minutes, the OLED display will be automatically turned off. At this time, there is no display on the OLED, and the leaf of the indicator window is green. You need to view the display data or make settings to make the OLED display again through touch operation.

9.3 Function setting



The inverter can support multiple touch modes: single touch, two consecutive touches, three consecutive touches, long press for 5S. Different types of taps have different functions. Advanced setting password: 123

All setting interfaces are as follows:

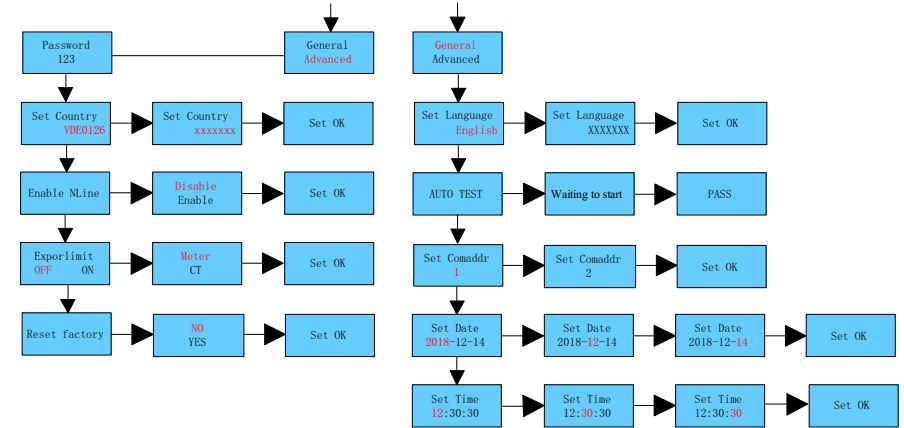

Fig 9.2

9.3.1 Select the protection voltage level

The factory setting of the inverter is CQC standard regulations. Customers can choose different voltage protection levels according to the actual situation; a single touch switches the voltage level, and two consecutive touches confirm the setting.

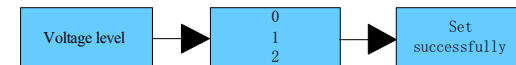



Fig 9.3

- 0 standard
- 1 Wide voltage level 2
- 2 Wide voltage level 3

Tips and disclaimers

When the inverter leaves the factory, the grid-connected voltage and frequency are set in accordance with the latest domestic standard; If the grid voltage is lower to or higher than the domestic legal requirements, the inverter cannot be connected to the grid. After obtaining the permission of the local power operator, the user can choose other voltage levels according to the voltage situation of the grid connection point.

	<p>Excessive grid voltage may affect the normal use and service life of home appliances on the grid-connected side, or cause loss of power generation. Our company does not accept any responsibility for the related impacts and consequences caused by enabling the automatic control function of output voltage to connect to the grid.</p>
--	--

9.3.2 Enabling/Disabling Power Quality Response Modes(PQRM) (Australia model only)

	<p>PQRM setting</p> <ul style="list-style-type: none"> When the Region setting is completed, the inverter will operate under default mode different from region.
--	--

MIN TL-X contains five types Power Quality Response Modes : Volt-Var, Volt-watt, Fixed PF, Reactive power, Power limit. If you want to change the Power Quality Response Modes please refer to chapter 7.3.1.

9.3.3 Check firmware version,Region,Country/Area and Power Quality Response Modes (Australia model only)

Single touch to switch display.
Double touch to enter next stage menu.

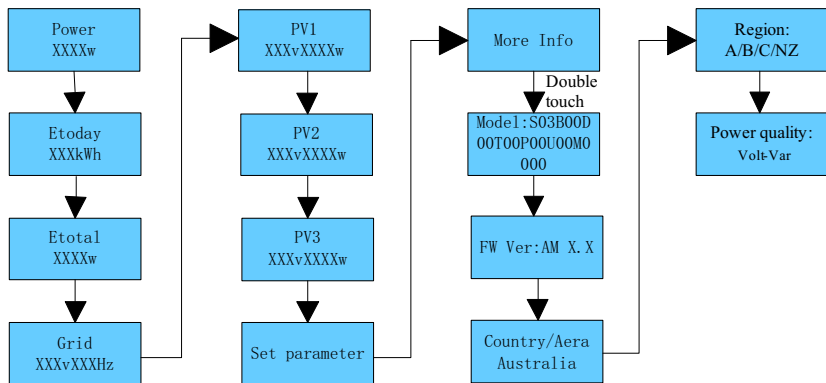

9.3.4 Check firmware version,Region,Country/Area and Power Quality Response Modes (Australia model only)

The inverter power output will vary in response to the AC grid voltage. This is switched on by default. This function belongs to advanced function, if you need to change, please contact the after-sales operation and maintenance to make adjustments.

Reset Country

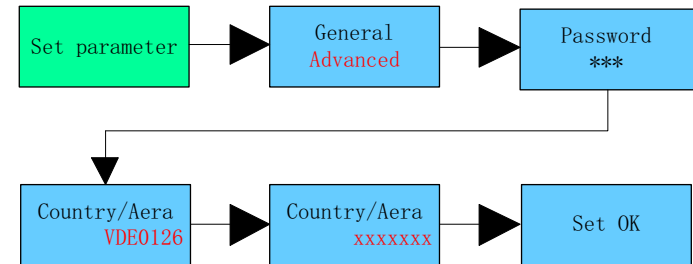

Reset Region

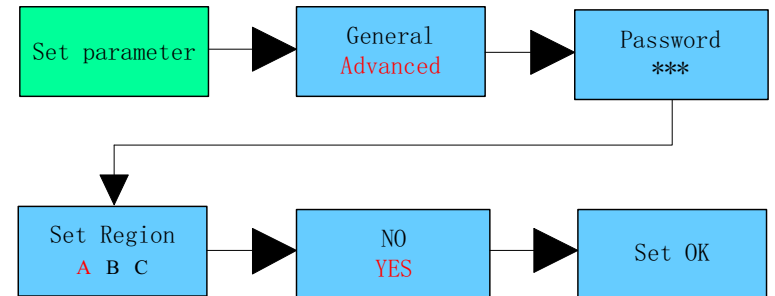

Reset PQRM

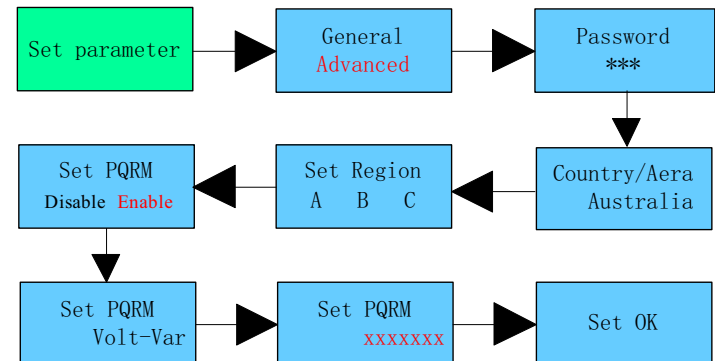

9.3.5 Generation & Export limitation control and Power Sensor setting (Australia model only)

Single touch to switch display or make the number + 1.

Double touch to confirm you setting.

Control type:

SW stands for enabling software limit control function

HW stands for enabling hardware limit control function

Both stands for enabling software and hardware limit control function at the same time.

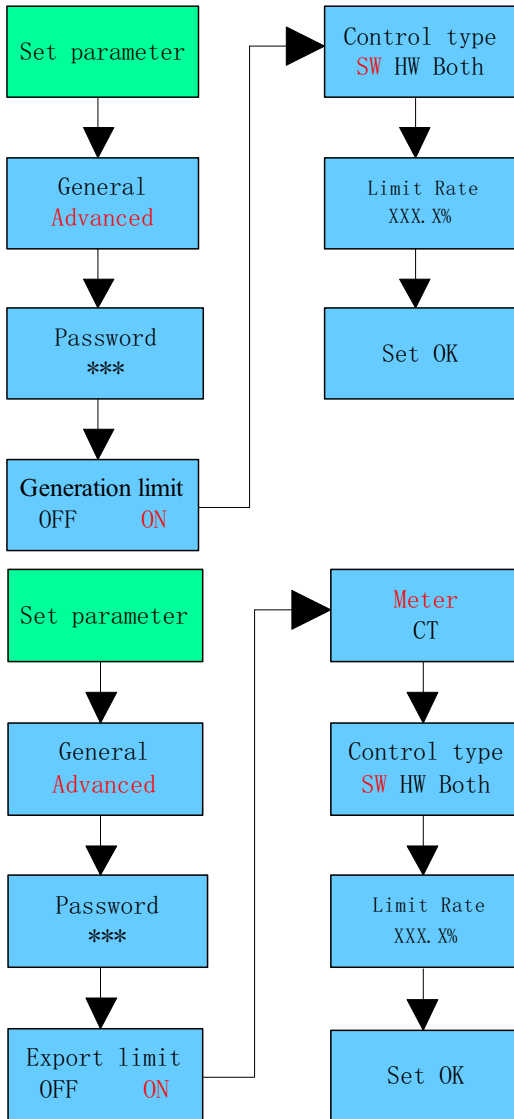

9.3.6 Set language

The default language is English, touch twice in a row to enter the setting mode, a single touch to switch the language, and touch twice to confirm the setting.



Fig 9.4

9.3.7 Set COM address

The default COM address is 1. Touch twice in a row to enter the setting mode, single touch, the number +1, touch twice in a row to confirm the setting, long press for 5S number to return to zero.

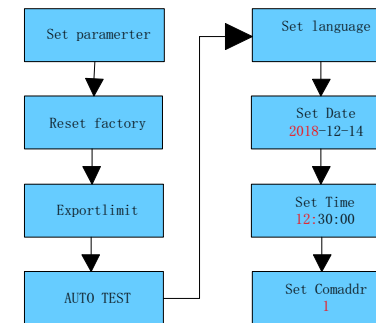

Fig 9.5

9.3.8 Set date and time

Touch twice to enter the parameter setting submenu, select the general setting, touch twice to enter the general setting submenu, single touch to switch the display interface, touch twice in the date and time interface to enter the setting state, single touch, number +.

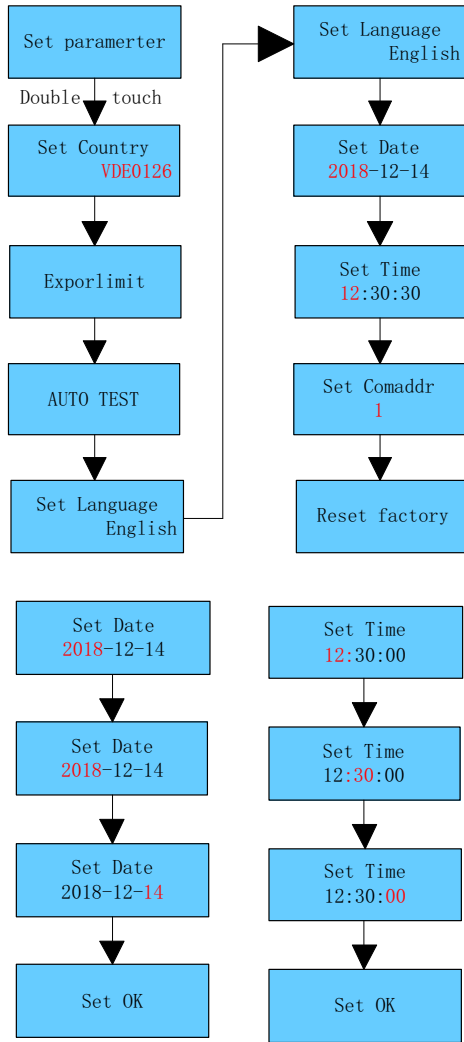
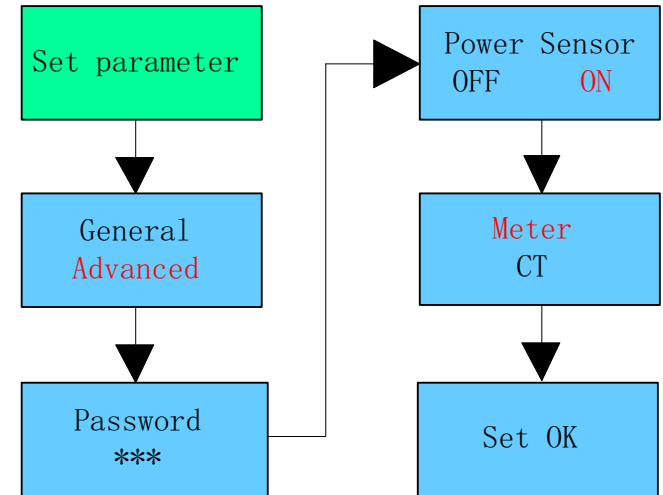

Fig 9.5

9.3.9

Under the permission given by your energy provider, the ratio of your system output power divided by the rated power of the inverter is called Limit Rate. For instance, if the energy provider only accepts 8kVA/kW from your 10kW system, then the Limit Rate of 10kW inverter is 80.0%.



9.3.10 Adjust the setpoints from the regional default values(Australia model only)

The power output or input will vary in response to the AC grid voltage. This function is switched off by default. This function belongs to advanced function, if you need to change, please contact the after-sales operation and maintenance to make adjustments.

10 Communication and Monitoring

10.1 RS485

This series of inverters provide two RS485 ports. You can monitor one or more inverters via RS485. The other RS485 port is used to connect a smart meter (stand-alone anti-backflow function).

No.	Description	Remarks
1	+12V	Auxiliary output for driving an external 2 W relay providing the "dry contact" feature
2	COM	
3	RS485A1	Rs485 communication port
4	RS485B1	
5	RS485A2	BAT communication port(reserved)
6	RS485B2	
7	RS485A3	Meter communication port
8	RS485B3	
9	DRM1/5	Relay contact 1 input/DRM5 command
10	DRM2/6	Relay contact 1 input/DRM6 command
11	DRM3/7	Relay contact 1 input/DRM7 command
12	DRM4/8	Relay contact 1 input/DRM8 command
13	REF/GEN	Relay&DRM signal reference
14	DRM0/COM	Relay common node

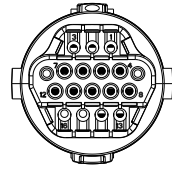

Fig 10.1

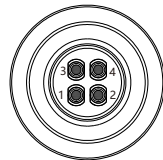

Fig 10.2 just for Vietnam models

No.	Description	Remarks
1	RS485A1	RS485 communication port
2	RS485B1	
3	RS485A2	BAT-RS485 port
4	RS485B2	

10.2 USB-A

USB-A port is mainly used to connect monitoring module or firmware update : We can connect the external optional monitoring modules, such as Shine WIFI-X, Shine Shine 4G-X, Shine LAN-X, etc. to the USB interface for monitoring.

Steps for installing the monitoring module: Make sure ▲ is on the front side, then insert the datalogger and tighten the screws.

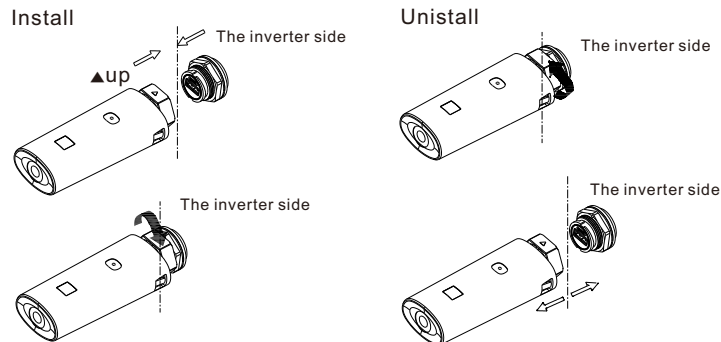

Fig 10.3

Maintenance and Cleaning 11

11.1 Checking Heat Dissipation

If the inverter regularly reduces its output power due to high temperature, please improve the heat dissipation condition. Maybe you need to clean the heat sink.

11.2 Cleaning the Inverter

If the inverter is dirty, turn-off the AC breaker and DC switch, waiting the inverter shut down, then clean the enclosure lid, the display, and the LEDs using only a wet cloth. Do not use any cleaning agents (e.g. solvents or abrasives).

11.3 Checking the DC Disconnect

Check for externally visible damage and discoloration of the DC Disconnect and the cables at regular intervals. If there is any visible damage to the DC Disconnect, or visible discoloration or damage to the cables, contact the installer.

- Once a year, turn the rotary switch of the DC Disconnect from the On position to the Off position 5 times in succession. This cleans the contacts of the rotary switch and prolongs the electrical endurance of the DC Disconnect.

Start and shut down the inverter 12

12.1 Start the inverter

1. Close the inverter AC circuit breaker.
2. Close the DC switch, when the input PV voltage is higher than 250Vdc, and the inverter will start automatically.

12.2 Shut down the inverter

 Danger	Don't disconnect the DC connector while the inverter is connected to the grid.
-------------------	--

Steps to turn off the inverter:

1. Disconnect the AC circuit breaker to prevent the inverter from starting again;
2. Turn off the DC switch;
3. Check the operating status of the inverter;
4. Wait until the LED and OLED display are off, indicating that the inverter is turned off.

13 Maintenance , Repair and Cleaning (Australia model only)



Prior to removal of any cover for maintenance or repair, turn off the switch on the AC and DC sides.

Troubleshooting 14

14.1 Error message

When a malfunction occurs, an error message will be displayed on the OLED screen. Faults include system faults and inverter faults.

In some cases, you may be advised to contact Growatt, please provide the following information.

Information about the inverter:

- Serial number
- Model
- Error message on OLED
- A short description of the problem
- Grid voltage
- DC input voltage
- Can you reproduce the failure? If so, how?
- Has this problem occurred in the past?
- What were the environmental conditions when the problem occurred?

Information about photovoltaic panels:

- PV panel manufacturer's name and model
- Panel output power
- Voc of the panel
- Vmp of the panel
- Imp of the panel
- The number of panels in each string
- If you need to replace the device, please ship it to the original box.

14.2 System error

Warning Code

Warning message	Description	Suggest
Warning 200	Panel access failure	1.Check whether the panel is normal after shutting down; 2.If the fault message still exists,contact the manufacturer.
Warning 201	String/PID quick connect terminal abnormal	1.Check the string terminal wiring after shutdown; 2.If the fault message still exists, contact the manufacturer.
Warning 202	DC lightning protection device alarm	1.Check the DC lightning arrester after shutdown; 2.If the fault message still exists,contact the manufacturer.
Warning 203	Panel short circuit	1.Check whether the first or second road panel or circuit is short-circuited; 2.If the fault message still exists, contact the manufacturer.
Warning 204	Dryconnect function abnormal	1.Check the dry node wiring after shutdown; 2.If the fault message still exists,contact the manufacturer.
Warning 205	Boost drive abnormal	1.Restart the inverter; 2.If the fault message still exists,contact the manufacturer.
Warning 206	AC SPD function abnormal	1.After shutdown,Check the AC SPD. 2.If error message still exists,contact manufacturer.

Warning message	Description	Suggest
Warning 207	USB overcurrent protection	1.Unplug the U disk; 2.Reconnect the U disk after shutdown; 3.If the fault message still exists,contact the manufacturer.
Warning 208	DC fuse is broken	1.Check the fuse after shutdown; 2.If the fault message still exists,contact the manufacturer.
Warning 209	Panel voltage is too high	1.Disconnect the DC switch immediately and confirm the voltage; 2.fter the normal voltage is restored, if the fault message still exists,contact the manufacturer.
Warning 210	Panel reverse	1.Check the panel input; 2.If the fault message still exists,contact the manufacturer.
Warning 300	No mains connection	1.Please confirm whether the power grid is lost; 2.If the fault message still exists,contact the manufacturer.
Warning 301	Mains voltage is out of range	1.Check whether the AC voltage is within the specification range of the standard voltage; 2.If the fault message still exists,contact the manufacturer.
Warning 302	Mains frequency is out of range	1.Check whether the frequency is within the range; 2.If the fault message still exists, contact the manufacturer.
Warning 303	Output overload	1.Reduce output power; 2.If the fault message still exists, contact the manufacturer.
Warning 304	Open current transformer	1.Check whether the current transformer is connected well; 2.If the fault message still exists, contact the manufacturer.
Warning 305	Reverse connection of current transformer	1.Check whether the current transformer is connected reversely; 2.If the fault message still exists,contact the manufacturer.
Warning 306	Communication failure of current transformer	1.Please check the communication line; 2.If the fault information still exists,contact the manufacturer.
Warning 307	Wireless CT pairing timeout	1.Please check the communication line; 2.If the fault information still exists,contact the manufacturer.
Warning 400	Fan function is abnormal	1.Check the fan wiring after shutdown; 2.Replace the fan; 3.If the fault information still exists,contact the manufacturer.

Warning message	Description	Suggest
Warning 401	The meter is abnormal	1.Check whether the meter is turned on; 2.Check whether the connection between the machine and the meter is normal.
Warning 402	Optimizer and inverter communication abnormal	1.Check if the optimizer is open; 2.Check whether the connection between the optimizer and the inverter is normal.
Warning 403	String communication abnormal	1.Check the string board wiring after shutdown; 2.If the fault message still exists,contact the manufacturer.
Warning 404	Memory exception	1.Restart the inverter; 2.If the fault message still exists, contact the manufacturer.
Warning 405	The firmware version of the control board and the communication board do not match	1.Check the firmware version; 2.If the fault message still exists, contact the manufacturer.
Warning 406	Boost circuit failure	1.Restart the inverter; 2.If the fault message still exists,contact the manufacturer.

14.3 System error

Error code	Description	Suggest
Error 200	DC arc abnormal	1. Check the panel terminal wiring after shutdown; 2. Restart the inverter; 3. If the fault message still exists, contact the manufacturer.
Error 201	Leakage current is too high	1. Restart the machine; 2. If the fault information still exists, contact the manufacturer.
Error 202	Panel voltage is too high	1. Disconnect the DC switch immediately and confirm the voltage; 2. After the normal voltage is restored, if the fault message still exists, contact the manufacturer.
Error 203	Low panel insulation resistance	1. After shutting down, check whether the panel shell is reliably grounded; 2. If the fault message still exists, contact the manufacturer.
Error 300	The mains voltage is abnormal	1. Check the grid voltage; 2. If the grid voltage has recovered to the allowable range and the fault information still exists, contact the manufacturer.
Error 301	AC wiring error	1. Please check the mains terminal; 2. If the fault message still exists, contact the manufacturer.
Error 302	No mains connection	1. Check the AC side line connection after shutdown; 2. If the fault message still exists, contact the manufacturer.
Error 303	Zero ground detection anomaly	1. Check the ground wire after shutting down to ensure that the ground wire is connected reliably; 2. If the fault message still exists, contact the manufacturer.
Error 304	Abnormal mains frequency	1. Detect grid frequency and restart; 2. If the fault message still exists, contact the manufacturer.
Error 305	Output overload protection	1. Check output load, reduce load power; 2. If the fault information still exists, contact the manufacturer.
Error 306	Reverse connection of current transformer	1. Check the connection direction of the current transformer after shutdown; 2. If the fault information still exists, contact the manufacturer.
Error 307	Communication failure of current transformer	1. Please check the communication line; 2. If the fault information still exists, contact the manufacturer.
Error 308	Pairing timeout	1. The pairing of the machine and the current transformer is overtime, re-pair; 2. If the fault information still exists, contact the manufacturer;

Error code	Description	Suggest
Error 400	Abnormal DC component offset	1. Restart the machine; 2. If the fault information still exists, contact the manufacturer.
Error 401	The output voltage DC component is too high	1. Restart the machine; 2. If the fault information still exists, contact the manufacturer.
Error 402	The output current DC component is too high	1. Restart the machine; 2. If the fault information still exists, contact the manufacturer.
Error 403	Unbalanced output current	1. Check whether the output current is unbalanced after shutdown; 2. If the fault message still exists, contact the manufacturer.
Error 404	Bus voltage sampling is abnormal	1. Restart the machine 2. If the fault information still exists, contact the manufacturer.
Error 405	Relay abnormal	1. Restart the machine; 2. If the fault information still exists, contact the manufacturer.
Error 406	Initialization mode exception	1. Reset mode; 2. If the fault message still exists, contact the manufacturer.
Error 407	Automatic detection failed	1. Restart the machine; 2. If the fault information still exists, contact the manufacturer.
Error 408	Temperature is too high	1. Check the temperature after shutdown, restart the inverter after normal; 2. If the fault message still exists, contact the manufacturer.
Error 409	Abnormal bus voltage	1. Restart the machine; 2. If the fault information still exists, contact the manufacturer.
Error 410	Inconsistent insulation resistance sampling	1. Restart the machine; 2. If the fault information still exists, contact the manufacturer.
Error 411	Internal communication abnormal	1. Check the wiring of the communication version after shutdown; 2. If the fault message still exists, contact the manufacturer.
Error 412	Temperature sensor connection abnormal	1. Check whether the temperature sampling module is properly connected after shutdown; 2. If the fault message still exists, contact the manufacturer.

Manufacturer warranty 15

Please refer to the warranty card.

Error code	Description	Suggest
Error 413	Drive exception	1.Restart the machine; 2.If the fault information still exists,contact the manufacturer.
Error 414	Memory exception	1.Restart the machine; 2.If the fault information still exists,contact the manufacturer.
Error 415	Abnormal auxiliary power supply	1.Restart the machine; 2.If the fault information still exists,contact the manufacturer.
Error 416	Overcurrent protection	1.Restart the machine; 2.If the fault information still exists,contact the manufacturer.
Error 417	The grid voltage sampling is inconsistent	1.Restart the machine; 2.If the fault information still exists,contact the manufacturer.
Error 418	The firmware version of the control board and the communication board do not match	1.Restart the machine; 2.If the fault information still exists,contact the manufacturer.
Error 419	Inconsistent leakage current sampling	1.Restart the machine; 2.If the fault information still exists,contact the manufacturer.
Error 420	Leakage current module is abnormal	1. Restart the machine; 2.If the fault information still exists,contact the manufacturer.
Error 421	CPLD abnormal	1.Restart the machine; 2.If the fault information still exists,contact the manufacturer.
Error 422	Redundant sampling is inconsistent	1.Restart the machine; 2.If the fault information still exists,contact the manufacturer.
Error 423	Abnormal battery reverse connection protection tube	1.Restart the machine; 2.If the fault information still exists,contact the manufacturer.
Error 424	Battery voltage sampling is inconsistent	1.Restart the machine; 2.If the fault information still exists,contact the manufacturer.
Error 425	AFCI self-check error	1.Restart the machine; 2.If the fault information still exists,contact the manufacturer.

Decommissioning 16

16.1 Dismantling the Inverter

1. Disconnect the inverter as described in section 8.
2. Remove all connection cables from the inverter.

	<p>Danger of burn injuries due to hot enclosure parts! Wait 20 minutes before disassembling until the housing has cooled down.</p>
---	--

3. Screw off all projecting cable glands.
4. Lift the inverter off the bracket and unscrew the bracket screws.

16.2 Packing the Inverter

If possible, always pack the inverter in its original carton and secure it with tension belts. If it is no longer available, you can also use an equivalent carton. The box must be capable of being closed completely and made to support both the weight and the size of the inverter.

16.3 Storing the Inverter

Store the inverter in a dry place where ambient temperatures are always between -25°C and +60°C.

16.4 Disposing of the Inverter



Do not dispose of faulty inverters or accessories together with household waste. Please accordance with the disposal regulations for electronic waste which apply at the installation site at that time. Ensure that the old unit and, where applicable, any accessories are disposed of in a proper manner

17 EU Declaration of conformity

With the scope of EU directives:

- 2014/35/EU Low Voltage Directive (LVD)
 - 2014/30/EU Electromagnetic Compatibility Directive (EMC)
 - 2011/65/EU RoHS Directive and its amendment (EU)2015/863
- Shenzhen Growatt New Energy Technology Co. Ltd confirms that the Growatt inverters and accessories described in this document are in compliance with the above mentioned

EU directives. The entire EU Declaration of Conformity can be found at www.ginverter.com.

Specification 18

18.1 Parameter

Specifications	Model	MID 17KTL3-X1	MID 20KTL3-X1	MID 22KTL3-X1	MID 25KTL3-X1
Input data(DC)					
Max. recommended PV power(for module STC)		25500W	30000W	33000W	37500W
Max. DC voltage		1100V			
Start voltage		250V			
Min. operating voltage		200V			
Nominal voltage		600V			
MPP voltage range		200-1000V			
No. of MPP trackers		3			
No. of PV strings per MPP trackers		2/2/2	2/2/2	2/2/2	2/2/2
Max. input current per MPP trackers		26A*3	26A*3	26A*3	26A*3
Max. short-circuit current per MPP trackers		32A*3	32A*3	32A*3	32A*3
Backfeed current to PV array		0A			
Output data(AC)					
Rated output power		17kW	20kW	22kW	25kW
Rated apparent power		17kVA	20kVA	22kVA	25kVA
Max. AC apparent		18.8kVA	22.2kVA	24.4kVA	27.7kVA
Nominal AC voltage/range		230/400V 340-440V			
AC grid frequency/range		50/60 Hz 45~55Hz/55-65 Hz			
Rated output current		24.6A	29.0A	31.9A	36.2A
Max. output current		28.6A	33.7A	37.0A	42.1A
Max output overload protection		40A/230V	40A/230V	50A/230V	50A/230V
Max. inrush current(Peak value/duration time)		29A/2ms	32A/2ms	34A/2ms	38A/2ms
AC inrush current		60A			
Max. output fault current(Peak value/duration time)		113.3A/10us			
Max. output fault current		106.1A			
Max. output overcurrent Protection		106.1A			
Power factor(@nominal power)		>0.99			
Adjustable power factor		0.8Leading ...0.8Lagging			
THDi		<3%			
AC grid connection type		3W+PE /3W+N+PE			
Overvoltage category		PV:II AC:III Others:I			
Efficiency					
Max. efficiency		98.75%	98.75%	98.75%	98.8%
Euro-eta		98.5%	98.5%	98.5%	98.5%

Specifications	Model	MID 17KTL3-X1	MID 20KTL3-X1	MID 22KTL3-X1	MID 25KTL3-X1
Protection devices					
DC reverse-polarity protection			YES		
DC switch			YES		
DC Surge protection			typeII OPT		
Insulation resistance monitoring			YES		
AC surge protection			typeII OPT		
AC short-circuit protection			YES		
Grid monitoring			YES		
Anti-islanding protection		Integrated(Active Frequency Drift)			
Residual-current monitoring unit			YES		
String Fuse protection			NO		
String monitoring			OPT		
AFCI protection			OPT		
General data					
Dimensions (W / H / D) in mm		580*435*230mm			
Weight		30.0kg			
Operating temperature range		-25°C ... +60°C (>45°C Derating)			
Noise emission (typical)		≤50dB(A)			
Altitude		4000m			
Internal consumption at night		1W			
Topology		Non-isolated			
Cooling		Smart air cooling			
Electronics protection degree		IP66			
Relative humidity		0~100%			
DC connection		H4/MC4(OPT)			
AC connection		Waterproof PG head+OT terminal or quick connect terminal			
Interfaces					
Display		OLED+LED			
USB/RS485		YES			
WIFI/GPRS/4G/RF/LAN		OPT			

Specifications	Model	MID 30KTL3-X	MID 33KTL3-X	MID 36KTL3-X	MID 40KTL3-X
Input data(DC)					
Max. recommended PV power(for module STC)		45000W	49500W	54000W	60000W
Max. DC voltage		1100V			
Start voltage		250V			
Min. operating voltage		200V			
Nominal voltage		600V			
MPP voltage range		200-1000V			
No. of MPP trackers		3		4	
No. of PV strings per MPP trackers		2/2/2	2/2/2	2/2/2/2	2/2/2/2
Max. input current per MPP trackers		26A*3	26A*3	26A*4	26A*4
Max. short-circuit current per MPP trackers		32A*3	32A*3	32A*4	32A*4
Backfeed current to PV array		0A			
Output data(AC)					
Rated output power		30000W	33000W	36000W	40000W
Rated apparent power		30000VA	33000VA	36000VA	40000VA
Max. AC apparent		33300VA	36600VA	40000VA	44400VA
Nominal AC voltage/range		230/400V 340-440V			
AC grid frequency/range		50/60 Hz 45~55Hz/55-65 Hz			
Rated output current		43.5A	47.8A	52.2A	58.0A
Max. output current		50.5A	55.6A	60.6A	67.3A
Max output overload protection		80A/230V	80A/230V	100A/230V	100A/230V
Max. inrush current(Peak value/duration time)		41A/2ms	46A/2ms	52A/2ms	57A/2ms
AC inrush current		60A			
Max. output fault current(Peak value/duration time)		113.3A/10us	113.3A/10us	132.2A/10us	132.2A/10us
Max. output fault current		106.1A	106.1A	124.8A	124.8A
Max. output overcurrent Protection		106.1A	106.1A	124.8A	124.8A
Power factor(@nominal power)		>0.99			
Adjustable power factor		0.8Leading ...0.8Lagging			
THDi		<3%			
AC grid connection type		3W+PE /3W+N+PE			
Overvoltage category		PV:II AC:III Others:I			
Efficiency					
Max. efficiency		98.8%			
Euro-eta		98.5%			

Specifications	Model	MID 30KTL3-X	MID 33KTL3-X	MID 36KTL3-X	MID 40KTL3-X
Protection devices					
DC reverse-polarity protection		YES			
DC switch		YES			
DC Surge protection		typeII OPT			
Insulation resistance monitoring		YES			
AC surge protection		typeII OPT			
AC short-circuit protection		YES			
Grid monitoring		YES			
Anti-islanding protection		Integrated(Active Frequency Drift)			
Residual-current monitoring unit		YES			
String Fuse protection		NO			
String monitoring		OPT			
AFCL protection		OPT			
General data					
Dimensions (W / H / D) in mm		580*435*230mm			
Weight		30kg		31kg	
Operating temperature range		-25°C ... +60°C (>45°C Derating)			
Noise emission (typical)		≤50dB(A)			
Altitude		4000m			
Internal consumption at night		1W			
Topology		Non-isolated			
Cooling		Smart air cooling			
Electronics protection degree		IP66			
Relative humidity		0~100%			
DC connection		H4/MC4(OPT)			
AC connection		Waterproof PG head+OT terminal or quick connect terminal			
Interfaces					
Display		OLED+LED			
USB/RS485		YES			
WIFI/GPRS/4G/RF/LAN		OPT			

Specifications	Model	MID 17KTL3-X1-AU	MID 20KTL3-X1-AU	MID 22KTL3-X1-AU	MID 25KTL3-X1-AU
Input data(DC)					
Max. recommended PV power(for module STC)		25500W	30000W	33000W	37500W
Max. DC voltage		1100V			
Start voltage		250V			
Min. operating voltage		200V			
Nominal voltage		600V			
MPP voltage range		200-1000V			
No. of MPP trackers		3			
No. of PV strings per MPP trackers		2/2/2	2/2/2	2/2/2	2/2/2
Max. input current per MPP trackers		26A*3	26A*3	26A*3	26A*3
Max. short-circuit current per MPP trackers		32A*3	32A*3	32A*3	32A*3
Backfeed current to PV array		0A			
Output data(AC)					
Rated output power		17kW	20kW	22kW	25kW
Rated apparent power		17kVA	20kVA	22kVA	25kVA
Max. AC apparent		18.8kVA	22.2kVA	24.4kVA	27.7kVA
Nominal AC voltage/range		230/400V 340-440V			
AC grid frequency/range		50/60 Hz 45~55Hz/55-65 Hz			
Rated output current		24.6A	29.0A	31.9A	36.2A
Max. output current		28.6A	33.7A	37.0A	42.1A
Max output overload protection		40A/230V	40A/230V	50A/230V	50A/230V
Max. inrush current(Peak value/duration time)		29A/2ms	32A/2ms	34A/2ms	38A/2ms
AC inrush current		60A			
Max. output fault current(Peak value/duration time)		113.3A/10us			
Max. output fault current		106.1A			
Max. output overcurrent Protection		106.1A			
Power factor(@nominal power)		>0.99			
Adjustable power factor		0.8Leading ...0.8Lagging			
THDi		<3%			
AC grid connection type		3W+PE /3W+N+PE			
Overvoltage category		PV:II AC:III Others:I			
Efficiency					

Model Specifications	MID 17KTL3-X1-AU	MID 20KTL3-X1-AU	MID 22KTL3-X1-AU	MID 25KTL3-X1-AU
Max. efficiency	98.75%	98.75%	98.75%	98.8%
Euro-eta	98.5%	98.5%	98.5%	98.5%
Protection devices				
DC reverse-polarity protection	YES			
DC switch	YES			
DC Surge protection	typeII OPT			
Insulation resistance monitoring	YES			
AC surge protection	typeII OPT			
AC short-circuit protection	YES			
Grid monitoring	YES			
Anti-islanding protection	Integrated(Active Frequency Drift)			
Residual-current monitoring unit	YES			
String Fuse protection	NO			
String monitoring	OPT			
AFCI protection	OPT			
General data				
Dimensions (W / H / D) in mm	580*435*230mm			
Weight	30.0kg			
Operating temperature range	-25°C ... +60°C (>45°C Derating)			
Noise emission (typical)	≤50dB(A)			
Altitude	4000m			
Internal consumption at night	1W			
Topology	Non-isolated			
Cooling	Smart air cooling			
Electronics protection degree	IP66			
Relative humidity	0~100%			
DC connection	H4/MC4(OPT)			
AC connection	Waterproof PG head+OT terminal or quick connect terminal			
Interfaces				
Display	OLED+LED			
USB/RS485	YES			
WIFI/GPRS/4G/RF/LAN	OPT			

Model Specifications	MID 30KTL3-X-AU	MID 33KTL3-X-AU	MID 36KTL3-X-AU	MID 40KTL3-X-AU
Input data(DC)				
Max. recommended PV power(for module STC)	45000W	49500W	54000W	60000W
Max. DC voltage	1100V			
Start voltage	250V			
Min. operating voltage	200V			
Nominal voltage	600V			
MPP voltage range	200-1000V			
No. of MPP trackers	3		4	
No. of PV strings per MPP trackers	2/2/2	2/2/2	2/2/2/2	2/2/2/2
Max. input current per MPP trackers	26A*3	26A*3	26A*4	26A*4
Max. short-circuit current per MPP trackers	32A*3	32A*3	32A*4	32A*4
Backfeed current to PV array	0A			
Output data(AC)				
Rated output power	30000W	33000W	36000W	40000W
Rated apparent power	30000VA	33000VA	36000VA	40000VA
Max. AC apparent	33300VA	36600VA	40000VA	44400VA
Nominal AC voltage/range	230/400V 340-440V			
AC grid frequency/range	50/60 Hz 45~55Hz/55-65 Hz			
Rated output current	43.5A	47.8A	52.2A	58.0A
Max. output current	50.5A	55.6A	60.6A	67.3A
Max output overload protection	80A/230V	80A/230V	100A/230V	100A/230V
Max. inrush current(Peak value/duration time)	41A/2ms	46A/2ms	52A/2ms	57A/2ms
AC inrush current	60A			
Max. output fault current(Peak value/duration time)	113.3A/10us	113.3A/10us	132.2A/10us	132.2A/10us
Max. output fault current	106.1A	106.1A	124.8A	124.8A
Max. output overcurrent Protection	106.1A	106.1A	124.8A	124.8A
Power factor(@nominal power)	>0.99			
Adjustable power factor	0.8Leading ...0.8Lagging			
THDi	<3%			
AC grid connection type	3W+PE /3W+N+PE			
Overvoltage category	PV:II AC:III Others:I			

Specifications	Model	MID	MID	MID	MID
		30KTL3-X-AU	33KTL3-X-AU	36KTL3-X-AU	40KTL3-X-AU
Efficiency					
Max. efficiency		98.8%			
Euro-eta		98.5%			
Protection devices					
DC reverse-polarity protection		YES			
DC switch		YES			
DC Surge protection		typeII OPT			
Insulation resistance monitoring		YES			
AC surge protection		typeII OPT			
AC short-circuit protection		YES			
Grid monitoring		YES			
Anti-islanding protection		Integrated(Active Frequency Drift)			
Residual-current monitoring unit		YES			
String Fuse protection		NO			
String monitoring		OPT			
AFCI protection		OPT			
General data					
Dimensions (W / H / D) in mm		580*435*230mm			
Weight		30kg		31kg	
Operating temperature range		-25°C ... +60°C (>45°C Derating)			
Noise emission (typical)		≤50dB(A)			
Altitude		4000m			
Internal consumption at night		1W			
Topology		Non-isolated			
Cooling		Smart air cooling			
Electronics protection degree		IP66			
Relative humidity		0~100%			
DC connection		H4/MC4(OPT)			
AC connection		Waterproof PG head+OT terminal or quick connect terminal			
Interfaces					
Display		OLED+LED			
USB/RS485		YES			
WIFI/GPRS/4G/RF/LAN		OPT			

Specifications	Model	MID	MID	MID	MID	MID
		10KTL3-XL1	12KTL3-XL1	15KTL3-XL	17KTL3-XL	20KTL3-XL
Input data(DC)						
Max. recommended PV power(for module STC)		15000W	18000W	22500W	25500W	30000W
Max. DC voltage		1100V				
Start voltage		250V				
Nominal voltage		360V				
MPP voltage range		200-850V				
No. of MPP trackers		4				
No. of PV strings per MPP trackers		2/2/2/2	2/2/2/2	2/2/2/2	2/2/2/2	2/2/2/2
Max. input current per MPP trackers		26A*4	26A*4	26A*4	26A*4	26A*4
Max. short-circuit current per MPP trackers		32A*4	32A*4	32A*4	32A*4	32A*4
Backfeed current to PV array		0A				
Output data(AC)						
AC nominal power		10000W	12000W	15000W	17000W	20000W
Max. AC apparent		11100VA	13300VA	16600VA	18800VA	22200VA
Nominal AC voltage/range		127V/220V 101.6-139.7V 133V/230V 106.4-146.3V				
AC grid frequency/range		50/60 Hz 45~55Hz/55-65 Hz				
Max. output current		29.2A	35.0A	43.7A	49.6A	58.3A
AC inrush current		60A				
Max. output fault current		106.1A				
Max. output overcurrent Protection		106.1A				
Power factor(@nominal power)		>0.99				
Adjustable power factor		0.8Leading ...0.8Lagging				
THDi		<3%				
AC grid connection type		3W+PE /3W+N+PE				
Efficiency						

Model	MID 10KTL3-XL1	MID 12KTL3XL1	MID 15KTL3-XL	MID 17KTL3-XL	MID 20KTL3-XL
Max. efficiency	98.0%				
Euro-eta	97.5%				
Protection devices					
DC reverse-polarity protection	YES				
DC switch	YES				
DC Surge protection	typeII OPT				
Insulation resistance monitoring	YES				
AC surge protection	typeII OPT				
AC short-circuit protection	YES				
Grid monitoring	YES				
Anti-islanding protection	YES				
Residual-current monitoring unit	YES				
String Fuse protection	NO				
String monitoring	OPT				
AFCI protection	OPT				
General data					
Dimensions (W / H / D) in mm	580*435*230mm				
Weight	31.0kg				
Operating temperature range	-25°C ... +60°C (>45°C Derating)				
Noise emission (typical)	≤60dB(A)				
Altitude	4000m				
Internal consumption at night	1W				
Topology	Transformerless				
Cooling	Smart air cooling				
Electronics protection degree	IP66				
Relative humidity	0~100%				

Model	MID 10KTL3-XL1	MID 12KTL3-XL1	MID 15KTL3-XL	MID 17KTL3-XL	MID 20KTL3-XL
DC connection	H4/MC4(OPT)				
AC connection	Waterproof PG head+OT terminal or quick connect terminal				
Interfaces					
Display	OLED+LED/WIFI+APP				
USB/RS485	YES				
WIFI/GPRS/4G/RF/LAN	OPT				

18.2 DC connector and Isolator info(Australia model only)

DC connector	VP-D4/ MC4(opt)
Isolator*	NDG3V-50
Rated insulation voltage	1500V
Rated impulse withstand voltage	8kV
Suitability for isolation	Yes
Rating thermal current(I _{th})	63A
Rated operational current(I _e)	55A
Utilization category and/or PV utilization category	DC-21B/PV2
Rated short time withstand current (I _{cw})	700A
Rated short-circuit making capacity (I _{cm})	1.4kA
Rated breaking capacity	220A

*Only for Australia market.

Compliance certificates 19

18.3 Torque

Shell cover screw	12kgf.cm
AC terminal block	14kgf.cm
AC waterproof cover fixing screw	4kgf.cm
Security screws on the wall mount	20kgf.cm
Ground screw	20kgf.cm

18.4 Annex

Product attachments can be selected from the table below:

Name	Brief
Shine GPRS-X	USB interface GPRS monitoring module
Shine WIFI-X	USB interface WIFI monitoring module
Shine 4G-X	USB interface 4G monitoring module
Shine RF-X	USB interface RF monitoring module
Shine LAN-X	USB interface LAN monitoring module

The inverter can be repaired on site or transported to the Growatt service center for repair, or it can be replaced with a new one based on the model and service life of the machine.

The warranty does not include the cost of recovery and transportation of faulty equipment. The cost of installation or reinstallation of malfunctioning equipment should also be clearly excluded from other related logistics and processing costs incurred by warranty claims related to various aspects.

With the appropriate settings, the unit will comply with the requirements specified in the following standards and directives (dated: Dec./2018):

Model	Certificates
MID 17-40KTL3-X(1)/MID 10-20KTL3-XL	CE, IEC 62109, AS 4777.2, EN50549, N4105, C10/11, IEC 62116/61727, IEC 60068/61683

20 Contact us

If you have technical questions about our products, please contact the Growatt New Energy Service Hotline. We need the following information to provide you with the necessary help:

- Inverter type
- Inverter serial number
- Inverter error message code
- Inverter OLED display content
- Type and number of PV modules connected to the inverter
- Inverter communication method

Shenzhen Growatt New Energy Co., Ltd
4-13/F, Building A, Sino-German(Europe) Industrial Park,
Hangcheng Ave, Bao'an District, Shenzhen, China

T +86 755 2747 1942
E service@ginverter.com
W www.ginverter.com