



## ShineMaster-X User Manual

Copyright © Shenzhen Growatt New Energy Co.,Ltd. 2023. All rights reserved. No part of this document may be reproduced, stored in a retrieval system or transmitted, in any form or by any means, be it electronic, mechanical, photographic, magnetic or otherwise, without the prior written permission of Shenzhen Growatt New Energy Co.,Ltd. (hereinafter referred to as Growatt).

### **Notice**

All products, services and features are stipulated by the contract made between Growatt and the customer. All or part of the products, services and features described in this document may not fall under the scope of purchase or usage. Unless otherwise specified in the contract, Growatt makes no representations or warranties, express or implied with respect to this documentation. The content of this document is continually reviewed and amended, where necessary. However, discrepancies cannot be excluded. Growatt reserves the right to make changes to the material at any time and without notice in order to keep the document accurate and up-to-date. For the latest documents, you can visit our official website, scan the QR code on the manual or reach out to your distributor.

# Table of Contents

<b>1 About this manual</b>	<b>1</b>
1.1 Information on this manual	1
1.2 Target group	1
1.3 Manual usage	1
<b>2 Product introduction</b>	<b>2</b>
<b>3 Installation requirements</b>	<b>3</b>
<b>4 Install the equipment</b>	<b>4</b>
4.1 Install the ShineMaster-X	4
<b>5 Electrical connections</b>	<b>5</b>
5.1 Prepare the cables	5
5.2 Connect the PE cable	5
5.3 Connect the RS485 communication cable	6
5.4 Connect the DI signal cable	7
5.5 Connect the output power cable	8
5.6 Connect the AI signal cable	8
5.7 Connect the DO signal cable	9
5.8 Install the SIM card and the 4G antenna	10
<b>6 Power on the system</b>	<b>11</b>
<b>7 ShineMaster-X built-in page operations</b>	<b>12</b>
7.1 Login	12
7.1.1 Option 1: Access the built-in page with connection to the computer using an Ethernet cable	12
7.1.2 Option 2: Access the built-in page via the router	13
7.1.3 Computer IP address settings	16
7.2 Built-in page introduction	19
7.2.1 Layout	19
7.2.2 ShineMaster-X system information	20
7.2.3 ShineMaster-X product maintenance	20
7.2.4 ShineMaster-X system settings	21
7.2.5 ShineMaster-X device monitoring	22
7.3 ShineMaster-X communication configuration	22
7.3.1 ShineMaster-X RS485 communication configuration	22
7.3.2 ShineMaster-X CAN communication configuration	25

7.4 Add, delete or query devices for monitoring via ShineMaster-X.....	27
7.4.1 Add or delete a device.....	27
7.4.2 Delete a device.....	38
7.4.3 Check the device running information.....	39
7.5 ShineMaster-X server communication configuration.....	40
7.5.1 ShineMaster-X network configuration.....	40
7.5.2 ShineMaster-X server address settings.....	42
7.6 Power adjustment settings.....	43
7.6.1 Enable active power adjustment.....	43
7.6.2 Meter configuration.....	44
7.6.3 Adjustment management.....	45
7.6.4 Time mode settings.....	45
7.7 Third-party server configuration.....	48
7.7.1 Third-party server configuration over MODBUS TCP.....	48
7.7.2 Third-party server configuration over IEC104.....	49
7.8 Power plant relationship configuration.....	49
<b>8 Technical specifications .....</b>	<b>51</b>
<b>9 Contact us .....</b>	<b>52</b>



# 1 About this manual

## 1.1 Information on this manual

Dear users, thank you for choosing the ShineMaster-X datalogger developed and manufactured by Shenzhen Growatt New Energy Co., Ltd (hereinafter referred to as Growatt). We sincerely hope that this product can serve your needs. Meanwhile, your feedback on the product's performance and functionality would be most welcomed and appreciated. This manual is intended to provide detailed product information and instructions for installation, operation and maintenance.

## 1.2 Target group

This manual is intended for qualified personnel who install, commission and maintain the product and end users.

## 1.3 Manual usage

Read this manual carefully before installing and using the ShineMaster-X datalogger. Keep the document in a convenient place for future reference. The content of this document is continually reviewed and amended, where necessary. However, discrepancies cannot be excluded. The parameters and images in this document are for reference only, and the actual product prevails. For the latest document, you can download it from [oss.growatt.com](http://oss.growatt.com), contact our customer services or reach out to your distributor.

# Product introduction 2

- Before installing the equipment, please read through the User Manual to get familiar with product information and safety precautions.
- Insulated tools must be used when installing the equipment. For personal safety, please wear personal protective equipment.

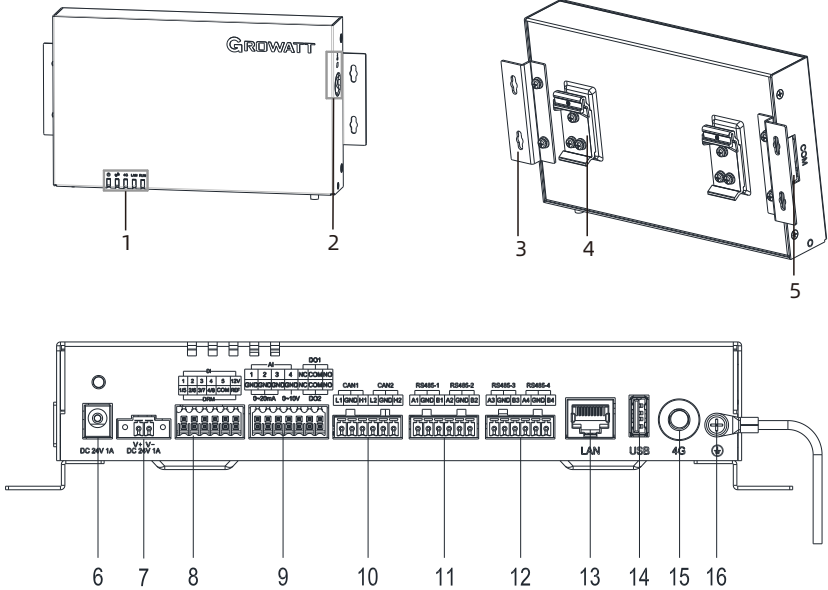

No.	Description	No.	Description
1	LED indicators (POWER, BLE, 4G, LAN, RUN)	9	24V power input port (DC IN 24V, 1A)
2	SIM card slot (SIM)	10	CAN port
3	Mounting ear	11	RS485-1, RS485-2
4	Guide rail clamp	12	RS485-3, RS485-4
5	COM port	13	GE port (LAN)
6	24V power input port (DC IN 24V, 1A)	14	USB port (USB)
7	DI port	15	4G antenna
8	AI (DO) port	16	Ground point

# 3 Installation requirements

## Dimensions:

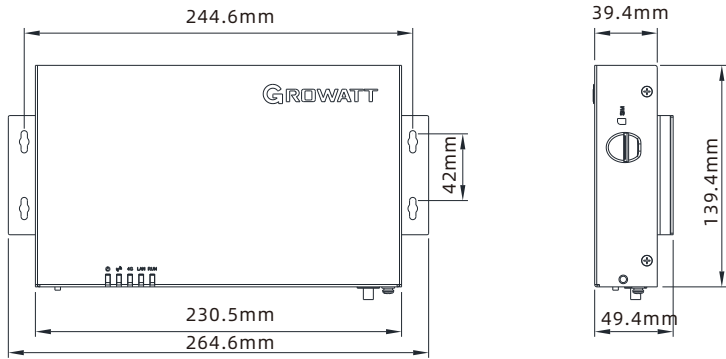

## Clearance:

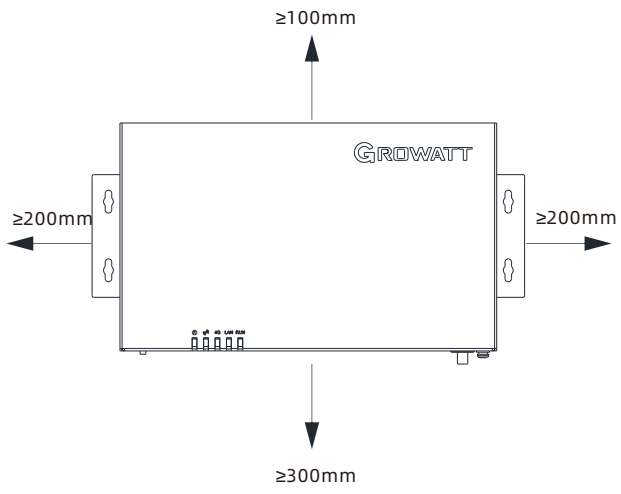

# Install the equipment 4

## 4.1 Install the ShineMaster-X

### Wall-mounted installation

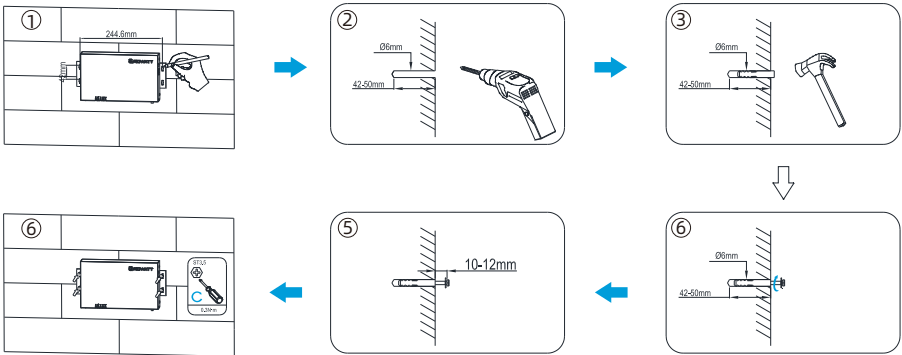

### Note:

- Install the device on a flat and solid wall surface indoors.
- When mounting the ShineMaster-X on a wall, make sure the cable connection area is facing downwards to facilitate cable connection and maintenance.
- It is recommended to use the self-tapping screws and expansion screws supplied with the package for installation.

### Install the guide rail

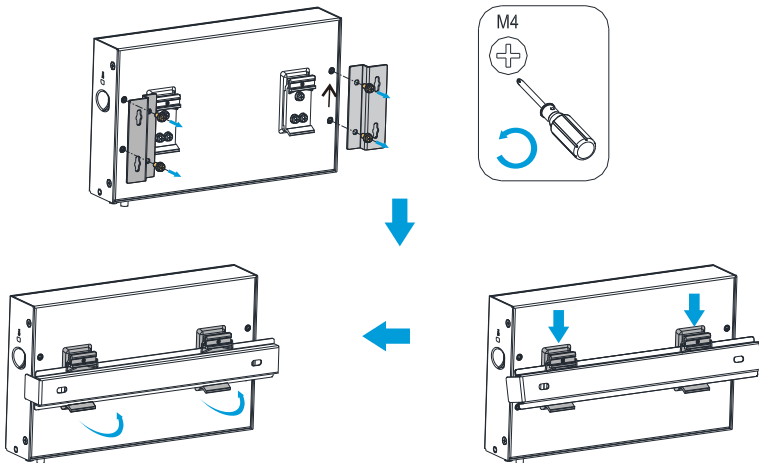

### Note:

- Before installation, please prepare a standard guide rail (35 mm) by yourself and attach it to the wall securely.
- The recommended effective length of the rail is greater than or equal to 260 mm.

# 5 Electrical connections

## 5.1 Prepare the cables

Cable type	Recommended specifications
PE cable	Cross-section area: 4mm <sup>2</sup> ~6mm <sup>2</sup> or 12AWG~10AWG outdoor copper cable
Rs485communication cable	Cross-section area: 0.2mm <sup>2</sup> ~2.5mm <sup>2</sup> or 24AWG~14AWG dual-/multi-core cable
MBUS cable (optional)	Delivered with the package
DI signal cable	Cross-section area: 0.2mm <sup>2</sup> ~1.5mm <sup>2</sup> or 24AWG~16AWG dual-/multi-core cable
Output power cable	
AI signal cable	
DO signal cable	
Ethernet cable	Delivered with the package

## 5.2 Connect the PE cable

### Note:

- To improve the corrosion resistance of the grounding terminal, it is recommended to apply silicone gel or paint to the grounding terminal after it is properly connected.

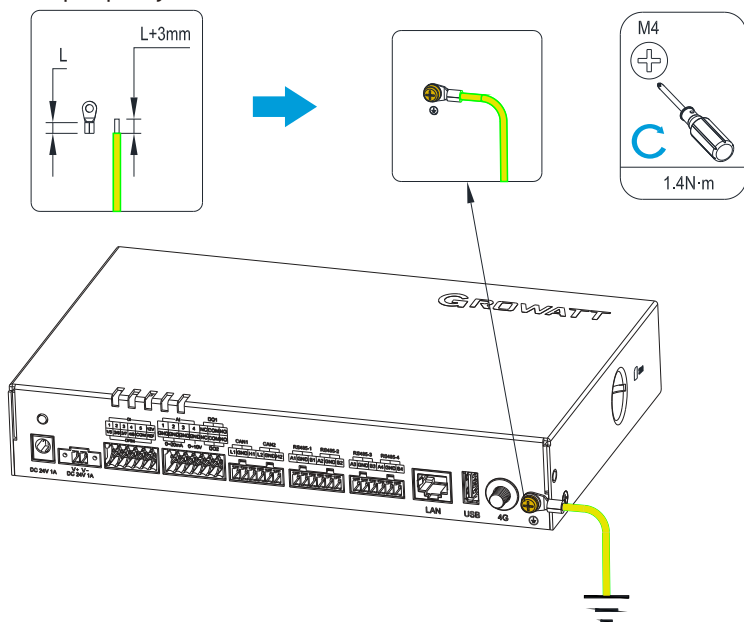

### 5.3 Connect the RS485 communication cable

**Note:**

- It is suggested that the RS485 communication distance be less than 500 m.
- The ShineMaster-X can be connected to RS485 communication devices, such as the inverter, the environmental monitor and the meter via the RS485 port.
- Please make sure that RS485+ is connected to RS485A of the ShineMaster-X, and RS485- to the RS485B port of the ShineMaster-X.

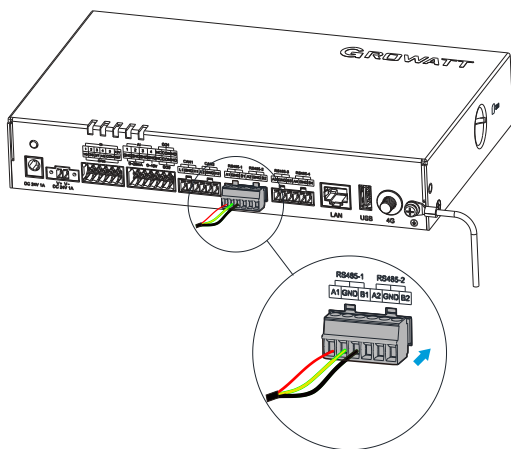
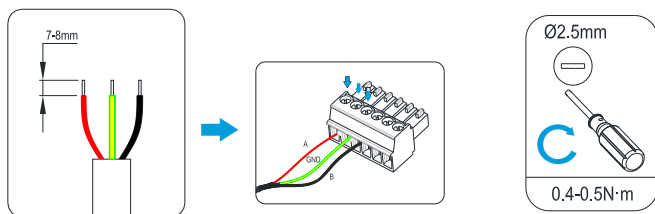

Port	Mark	Description
RS4851, RS4852, RS4853, RS4854	+	RS485A, RS485 differential signal +
	-	RS485B, RS485 differential signal -

#### Cascading

**Note:**

- It is recommended that the number of devices on each RS485 route is fewer than 12.
- The baud rate, communications protocol, and parity mode of all devices on an RS485 cascading link must be the same as those of the RS485 port on the ShineMaster-X.

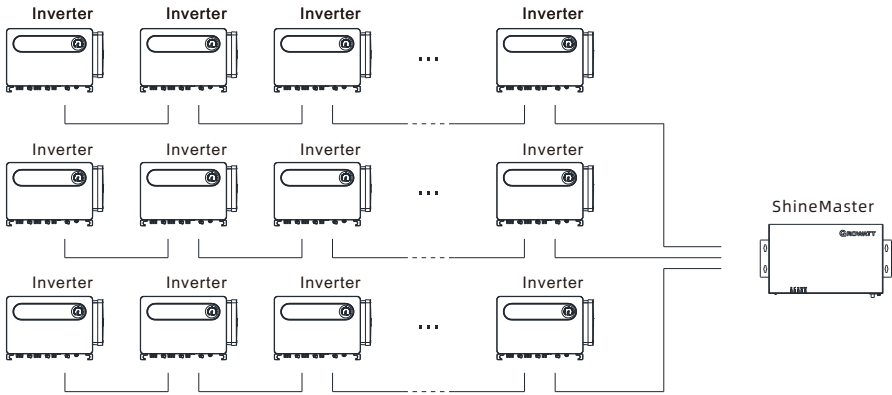

## 5.4 Connect the DI signal cable

### Note:

- The ShineMaster-X can receive DI signals such as remote grid dispatching commands and alarms over DI ports. It can only receive passive dry contact signals.
- It is recommended that the signal transmission distance be less than or equal to 10 m.

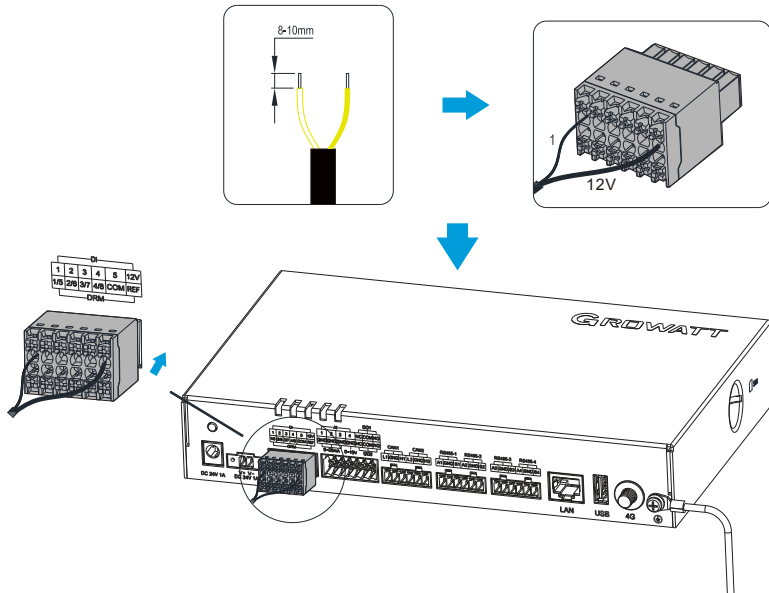

Port	Description
DI1	Support connection to passive dry contact signals
DI2	
DI3	
DI4	
DI5	

## 5.5 Connect the output power cable

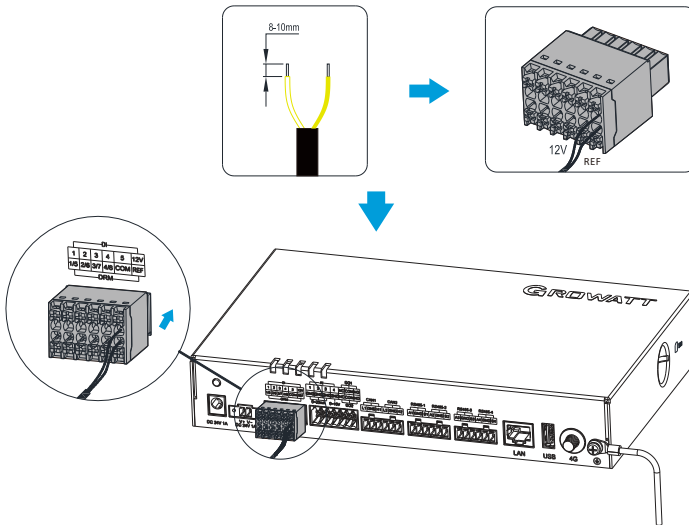

### Note:

- The ShineMaster-X can drive the coil of the intermediate relay via the 12V power output port in export limitation or audible-visual alarm scenario.
- It is recommended that the transmission distance be less than or equal to 10 m.

## 5.6 Connect the AI signal cable

### Note:

- The ShineMaster-X can receive AI signals from the environmental monitor via the AI port.
- It is recommended that the transmission distance be less than or equal to 10 m.
- AI ports 1, 2, 3 and 4 are for AI+ signals, and GND port is for AI- signals.



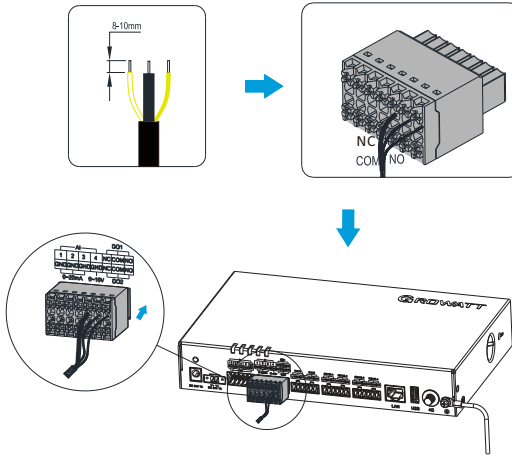

Port	Description
AI1	Supports input current of 4mA~20mA and 0mA~20mA
AI2	
AI3	
AI4	Supports input voltage of 0V~10V

## 5.7 Connect the AI signal cable

### Note:

- The DO port supports up to 12V signal voltage.
- It is recommended that the transmission distance be less than or equal to 10 m.

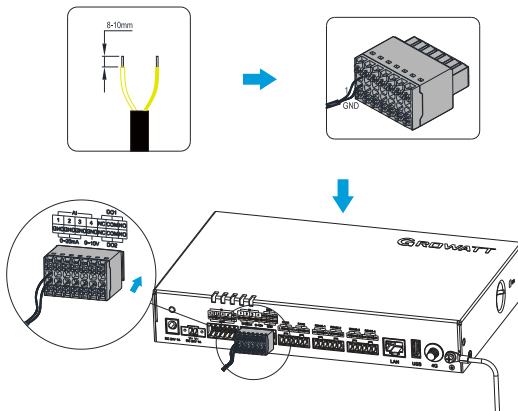

## 5.8 Install the SIM card and the 4G antenna

### Note:

- Please prepare a standard SIM card (dimensions: 15mm\*25mm). Determine the SIM card installation direction according to the silk screen.
- Press the SIM card in place to lock it. In this case, the SIM card is correctly installed.
- When removing the SIM card, push it inward to pop it out.

### Install the SIM card according to the silk screen:

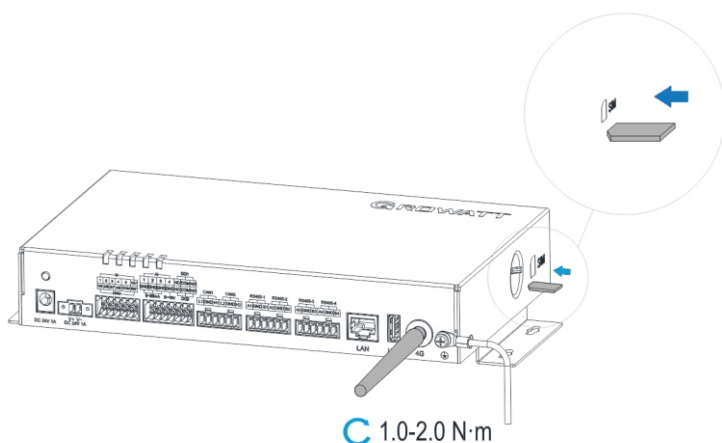

SIM card monthly traffic package requirement		Data baseline
Inverter	10MB + 30MB × number of inverters	<ul style="list-style-type: none"> <li>• Supports updating device performance data every 5 minutes.</li> <li>• Supports exporting inverters log and IV diagnosis data once a month, and upgrading the inverter monthly.</li> </ul>
Meter	3MB × number of meters	
Environmental monitor	3MB × number of environmental monitors	

# 6 Power on the system

## 1. Connect the power supply

- Connect the power adapter cable, then turn on the switch on the AC socket side.

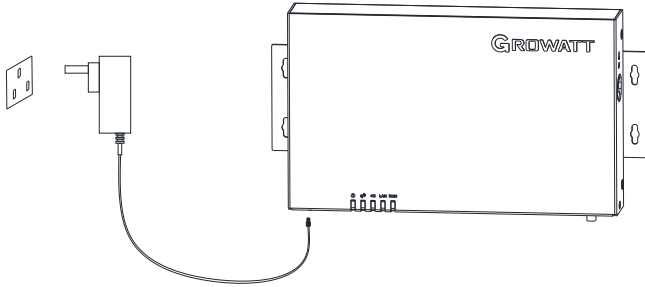

### Note:

- The rated input voltage of the power adaptor is 100V AC~240V AC, and the rated input frequency is 50Hz/60Hz.
- Please select an AC socket that matches the power adapter.

## 2. Observe the LED indicators to check the ShineMaster-X operating status

LED indicator	Meaning
Power indicator	Off: power supply is abnormal; Steady on: power supply is normal.
Bluetooth indicator (currently not supported)	Off: Bluetooth is not enabled; On for 0.5s and off for 0.5s: Bluetooth has been enabled, but does not connected to the APP; Steady on: Bluetooth is working properly and connection to the APP is normal.
4G indicator	Off: 4G function is not supported; Blink twice in 1s: SIM card is not installed On for 0.5s and off for 0.5s: 4G network is abnormal or the SIM card traffic has run out; Steady on: 4G network works normally.
LAN indicator	Off: not connected to the internet On for 0.5s and off for 0.5s: a valid IP address is obtained, but no network data interaction, which means an exception of connection to the server.
Status indicator	Off: system is operating properly and does not report any alarm or fault; Flashing blue: system reports an alarm. For instance, connection with the server is abnormal, or communication of the monitoring device failed Steady red: system reports a fault. For instance, the SD card or the MMC chip is abnormal, export limitation failed, lightning protection alarm, or the third-party alarm signal, etc.

# ShineMaster-X built-in page 7 operations

## 7.1 Login

### Note:

- The DHCP of ShineMaster-X is disabled by default before delivery, and the default IP address is: 192.168.0.254. Upon first use, please connect ShineMaster-X to the computer using an Ethernet cable to access the built-in page.

### 7.1.1 Option 1: Access the built-in page with connection to the computer using an Ethernet cable

- Connect ShineMaster-X to the computer with an Ethernet cable. Modify the computer IP to 192.168.0.XXX (XXX ranges from 2 to 253), referring to Section 7.1.3 Computer IP address settings.
- The default IP address of ShineMaster-X is 192.168.0.254. Input 192.168.0.254 into the address bar, then you can access the built-in page.



Fig 7-1 Default IP address

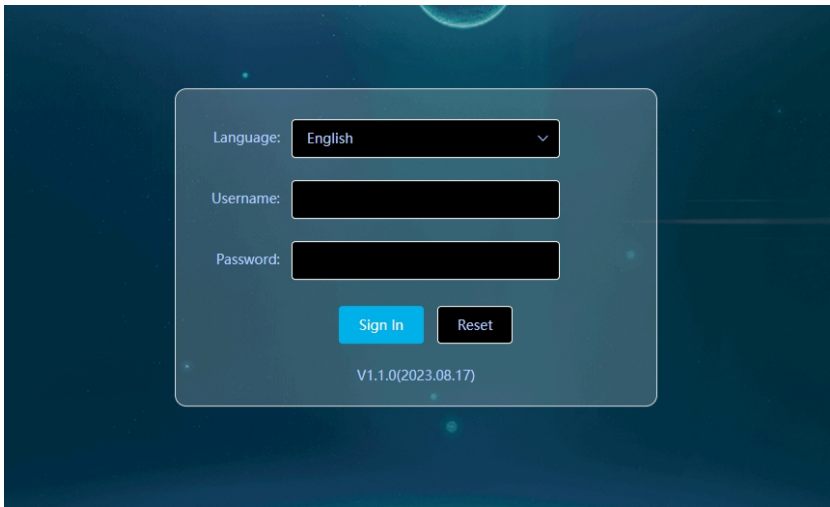

Fig 7-2 Login page

- Enter the username (admin) and password (admin) to sign in, then the “Login succeeded” message will pop up.

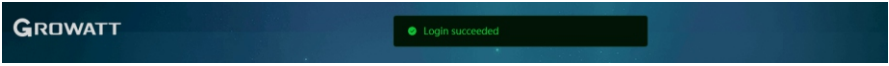

Fig 7-3 Successful login

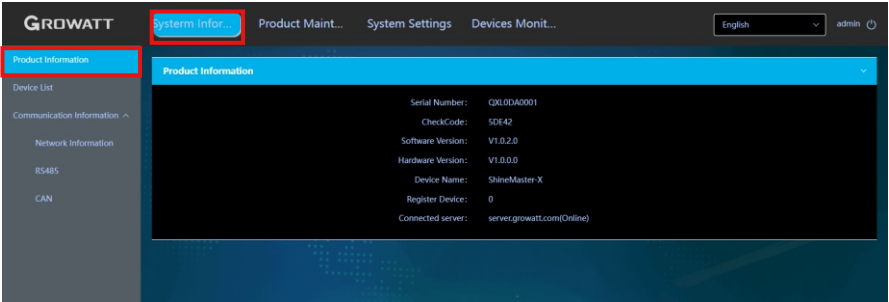

Fig 7-4 Built-in page

### 7.1.2 Option 2: Access the built-in page via the router

**Note:**

- The DHCP of ShineMaster-X is disabled by default before delivery. To access the built-in page via the router, you need to enable DHCP of ShineMaster-X first.
- Enable DHCP of ShineMaster-X: Enter the built-in page according to instructions in Section 7.1.1 with the initial username (admin) and password (admin). Then enable DHCP following instructions in Section 7.5.1.

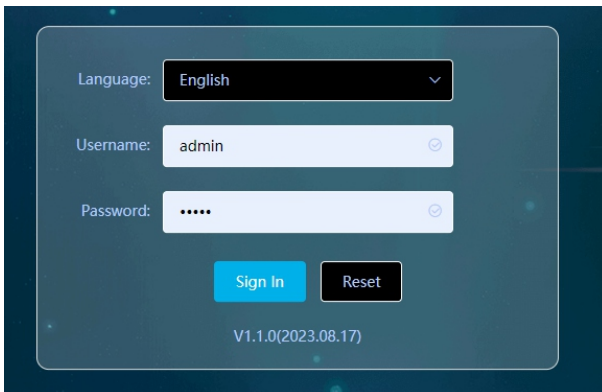

Fig 7-5 Login page

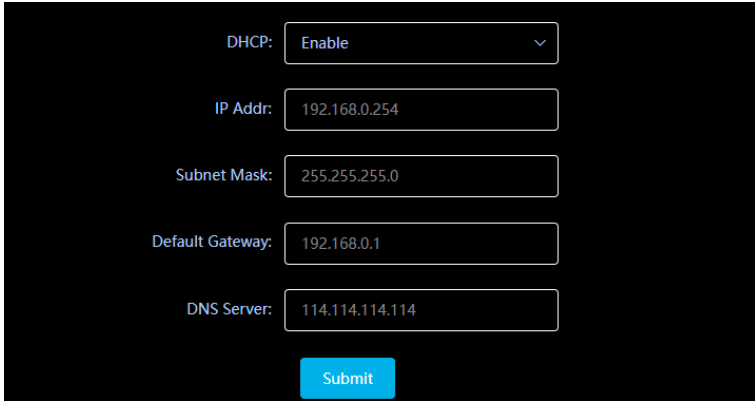

Fig 7-6 DHCP setting

- Verify if the ShineMaster-X has enabled DHCP function, then connect the PC and ShineMaster-X to the same router, ensuring that they are in the same network segment.
- Check the network segment the server is in.

**Take the TP\_LINK router as an example:**

Press “Windows” + “R”, enter “cmd” to open the command prompt. Input “ipconfig” to check the IP address that the router assigned to the computer.

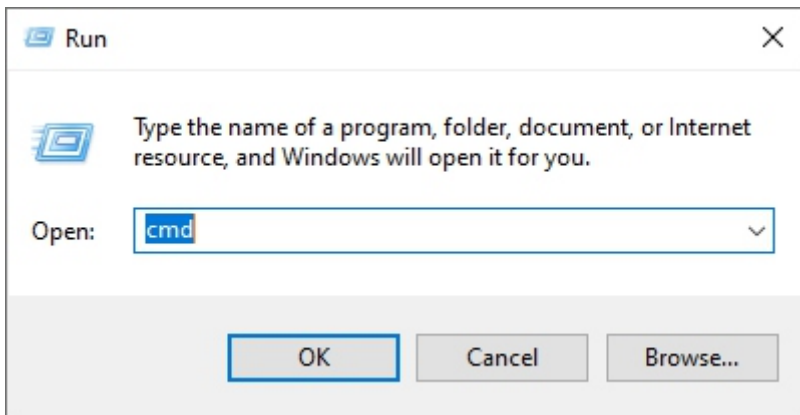

Fig 7-7 Type “cmd” into the Run window

```
C:\Users\sagel>ipconfig
```

Fig 7-8 IP query command

```
Wireless LAN adapter Wi-Fi:  
  
Connection-specific DNS Suffix . : home  
Link-local IPv6 Address . . . . . : fe80::1ba3:8a3e:4f2f:52bd%3  
IPv4 Address. . . . . : 192.168.1.74  
Subnet Mask . . . . . : 255.255.255.0  
Default Gateway . . . . . : 192.168.1.254
```

Fig 7-9 IP query field

- As we can see that the IP address assigned to the computer by the router is 192.168.10.220, so that the network segment of the router is 192.168.10.X. You can input 192.168.10.254 on the browser to access the built-in page.



Fig 7-10 Login IP address

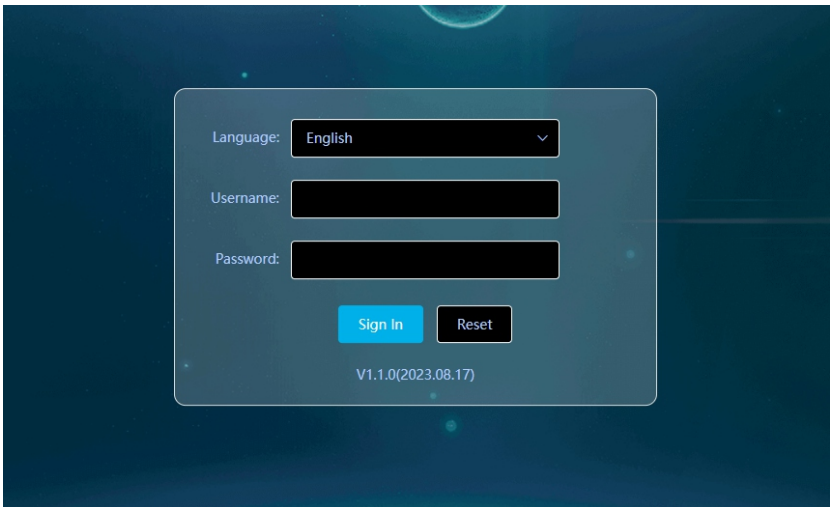

Fig 7-11 Login page

- Enter the username (admin) and password (admin) to sign in, and you can access the built-in page upon successful login.

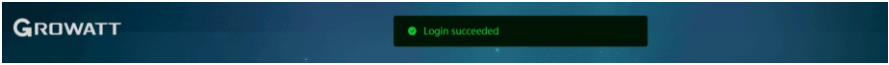

Fig 7-12 Successful login

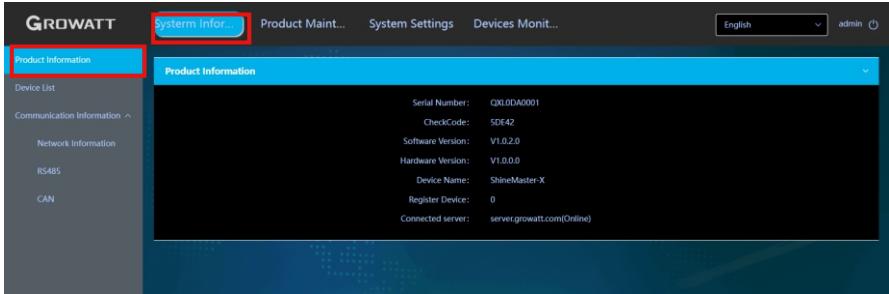

Fig 7-13 Built-in page

### 7.1.3 Computer IP address settings

- (1) Click the Start button in the lower-left corner > Control Panel > Network and Sharing Center.

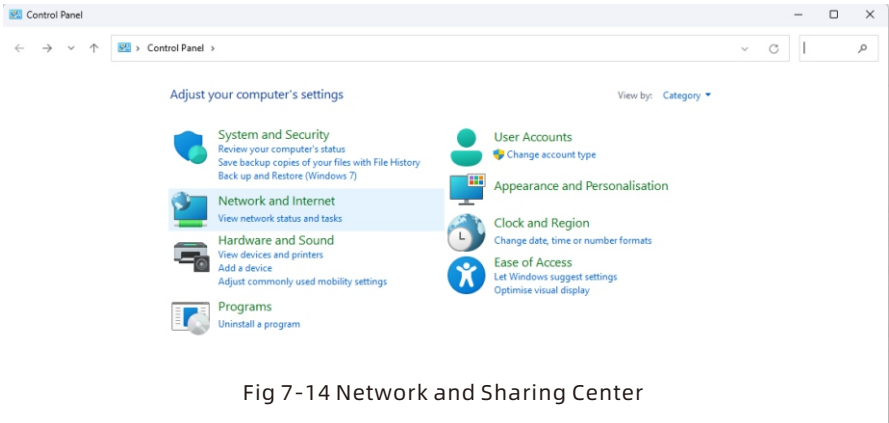

Fig 7-14 Network and Sharing Center



(2) Click Change Adapter Settings on the left pane.

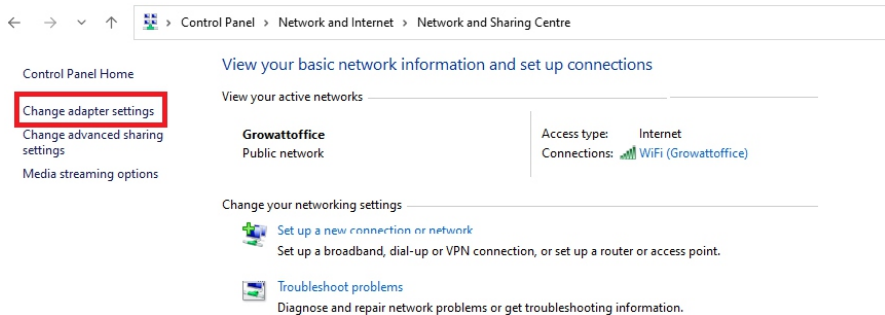

Fig 7-15 Change Adapter Setting

(3) Find the “Local Connection” icon. Double-click or right-click the Local Area Connection, and select “Property”.



Fig 7-16 Local Area Connection

(4) Select Internet Protocol Version 4 (TCP/IPv4) > Property.

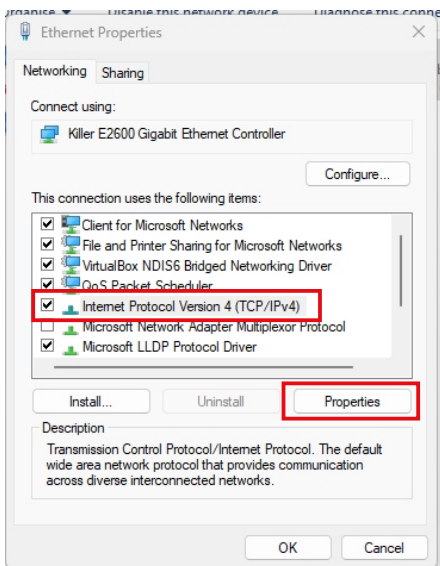

Fig 7-17 Ethernet properties

(5) In the Internet Protocol Version 4 (TCP/IPv4) window, select “Use the following IP address” , then input the IP address 192.168.0.XXX (XXX ranges from 2 to 253), the Subnet Mask: 255.255.255.0 and the Default Gateway: 192.168.0.1 . It is not required to set the DNS Server.

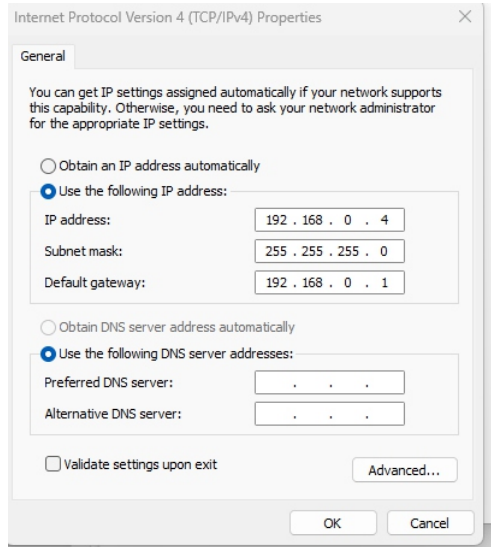

Fig 7-18 Change the IP address

(6) After the configuration is complete, click “Save” .

## 7.2 Built-in page introduction

### 7.2.1 Layout

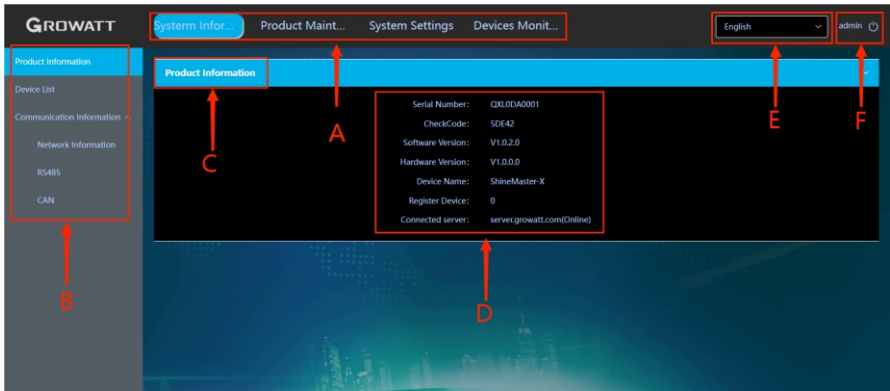

Fig 7-19 Built-in page layout

A	Main menu
B	Sub menu
C	Selected menu item
D	Information & Operation area
E	Language
F	Account & Log out

The Main Menu is on the top of the page labeled with A, including “System Information”, “Product Maintenance”, “System Settings” and “Devices Monitoring” sections. The Sub menu is on the left pane labeled with B and each item of sub menu has the independent operation area.

### 7.2.2 ShineMaster-X system information

➤ Under the System Information menu, you can view Product Information, Device List, and Communication Information, etc.

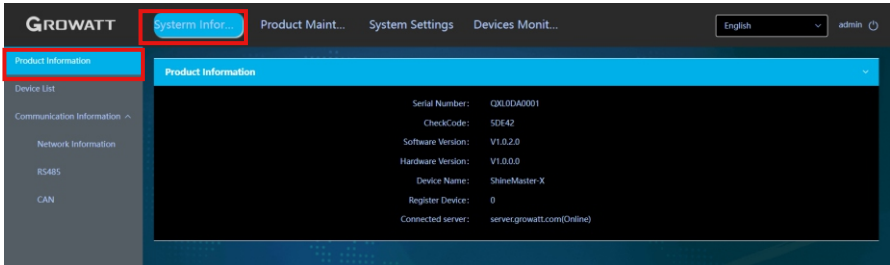

Fig 20 Product Information

Product Information	Serial Number of ShineMaster-X, software version, etc.
Device List	Information about added devices and online/offline status
Network Info	Detailed information about wired network and wireless network
RS485	Configuration of RS485-1, RS485-2, RS485-3 and RS485-4
CAN	CAN communication info

### 7.2.3 ShineMaster-X product maintenance

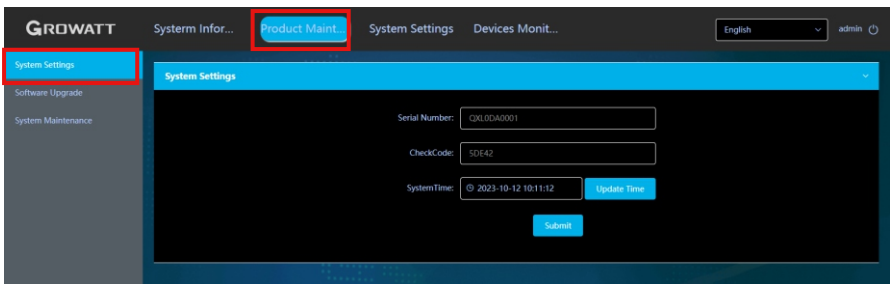

Fig 21 Product Maintenance

System Settings	Set ShineMaster-X serial number and the time
Software Upgrade	Online upgrade and local upgrade of ShineMaster-X software

## 7.2.4 ShineMaster-X system settings

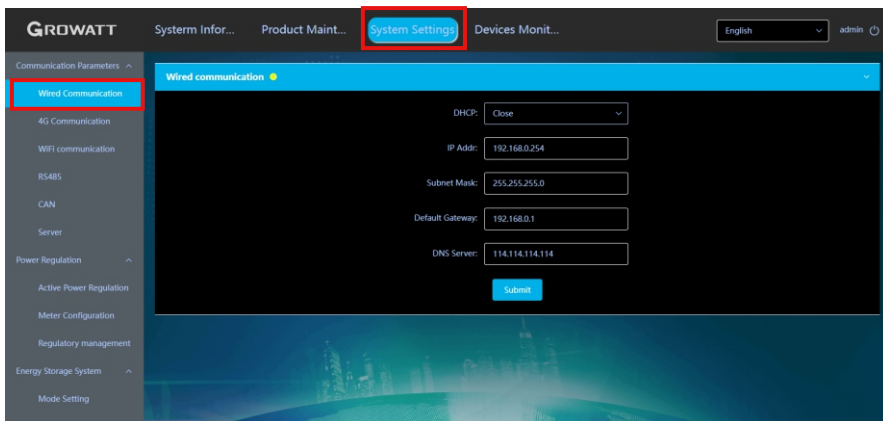

Fig 22 System Settings

Wired Communication	Parameter settings regarding ShineMaster-X connected to the server via the Ethernet port
Wireless Communication	Parameter settings regarding ShineMaster-X connected to the server via the network interface card (NIC)
RS485	Parameter settings regarding RS485-1, RS485-2, RS485-3 and RS485-4 communication
CAN	Parameter settings regarding CAN communication
Server	Domain name and upload interval settings of the connected server
Active Power Adjustment	Enable energy scheduling
Meter Configuration	Configure export limitation meter
Adjustment Management	Configure export limitation control method
Mode Settings	Configure Time-of-Use (TOU) control
Power Plant Relationship	Configure the multi-meter communication relationship chart

## 7.2.5 ShineMaster-X device monitoring

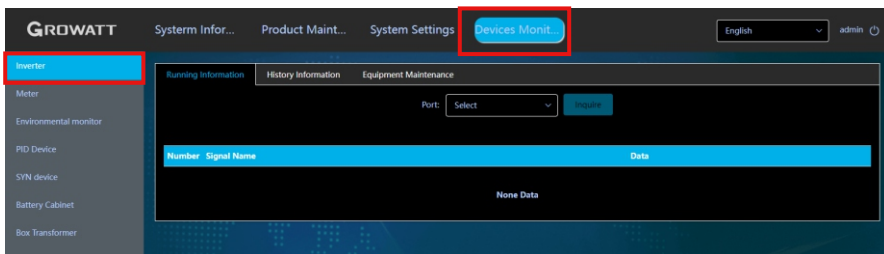

Fig 23 Device Monitoring

Running Info	Check information about devices in operation, including the inverter, meter, environmental monitor and PID device
Historical Information	Check historical data of devices in operation, including the inverter, meter, environmental monitor and PID device
Device Maintenance	Check, add or delete the inverter, meter, environmental monitor and PID device

## 7.3 ShineMaster-X communication configuration

### 7.3.1 ShineMaster-X RS485 communication configuration

#### Note:

The baud rate of the four routes RS485-1, RS485-2, RS485-3, RS485-4 is set to 9600 by default before delivery. You can set the baud rate respectively based on the installation environment.

(1) Sign into the built-in page referring to Section 7.1 with the username (admin) and password (admin). Select “RS485” from the left pane under the “System Settings” menu.

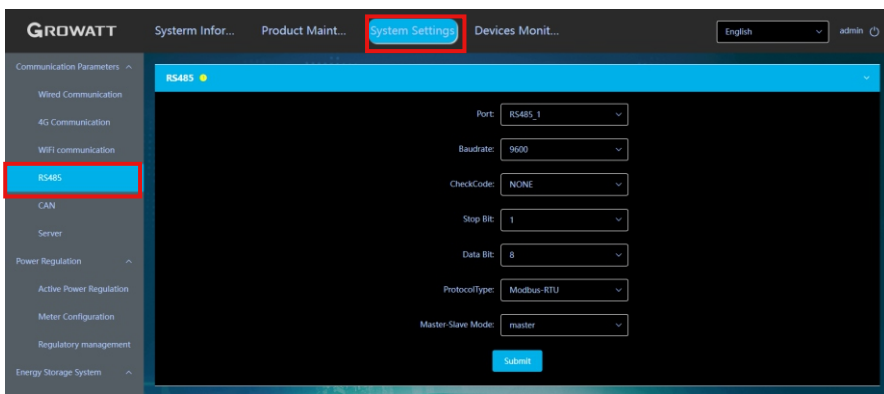

Fig 24 RS485 configuration

(2) Select the target RS485 route from the dropdown list of "Port". Four options are available: RS485-1, RS485-2, RS485-3 and RS485-4.

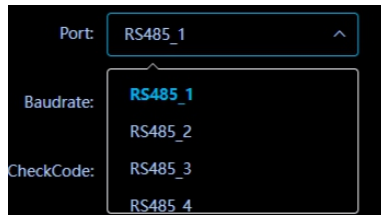

Fig 25 Set the RS485 route

(3) Select the Baud Rate from the dropdown list. The value can be set to "4800", "9600", "19200", "38400" or "115200".



Fig 26 Set the RS485 baud rate

(4) Select the Parity from the dropdown list. The value can be set to "None", "Odd parity", or "Even parity".

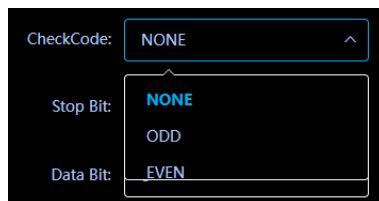

Fig 27 Set the RS485 parity

(5) Select the Stop Bit from the dropdown list. The value can be set to "1" or "2".

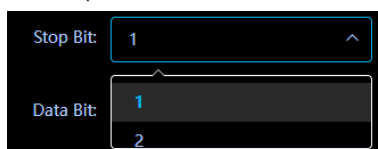

Fig 28 Set the RS485 stop bit

(6) Select the Data Bit from the dropdown list. The value can be set to "6", "7" or "8".

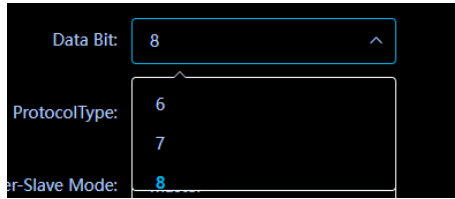

Fig 29 Set the RS485 data bit

(7) Select the target Modbus Protocol from the dropdown list of "Protocol Type" .

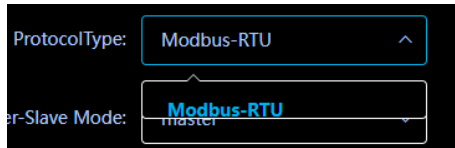

Fig 30 Set the protocol type

(8) Select "Master/Slave" from the dropdown list to set it to master mode or slave mode.



Fig 31 Set the RS485 master/slave mode

(9) After the configuration is complete, select "Submit" . Then it will display "Setting succeeded" .

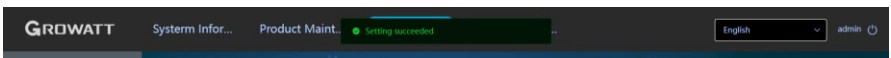

Fig 32 Successful configuration



(10) Verify if the RS485 configuration is successful by selecting “RS485” on the left pane under the “System Information” menu.

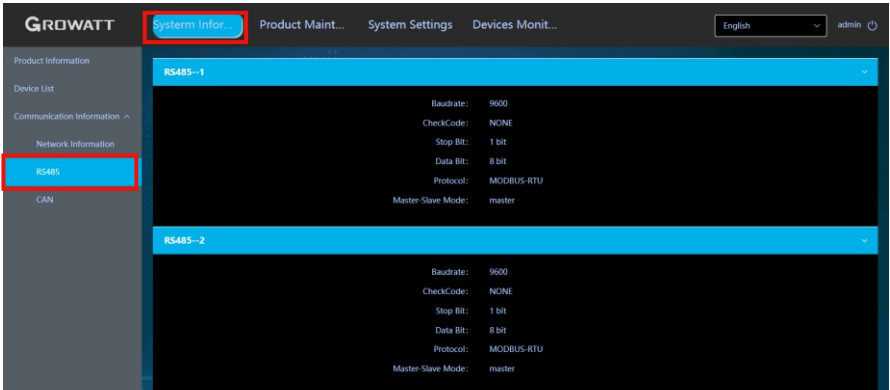

Fig 33 RS485 configuration

### 7.3.2 ShineMaster-X CAN communication configuration

(1) Sign in in the built-in page referring to Section 7.1 with the username (admin) and password (admin). Select “CAN” from the left pane under the “System Settings” menu.

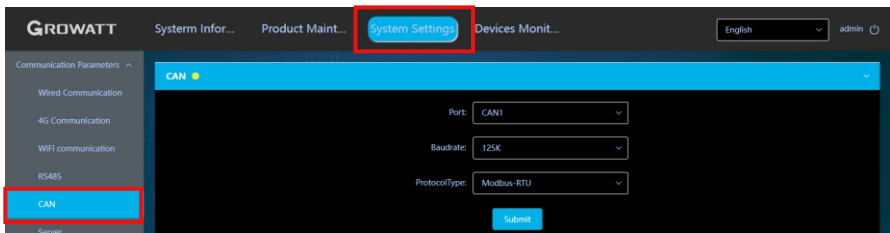

Fig 34 CAN configuration

(2) Select the target CAN route from the dropdown list of “Port” . Two options are available: CAN 1 and CAN 2.

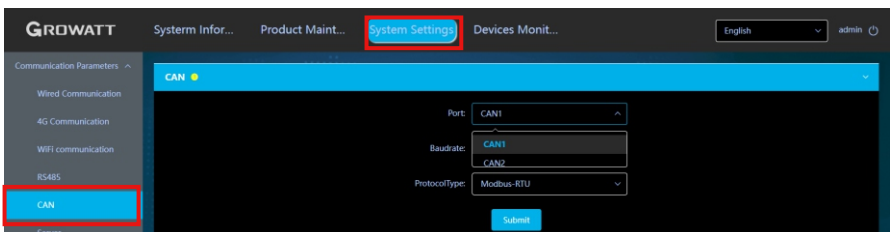

Fig 35 Set the CAN port

(3) Select the Baud Rate from the dropdown list. The value can be set to “125K” , “250K” , or “500K” .

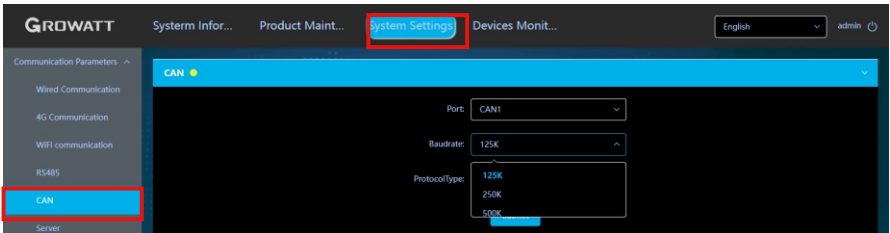

Fig 36 Set the CAN baud rate

(4) Select the target Modbus Protocol from the dropdown list of “Protocol Type” .

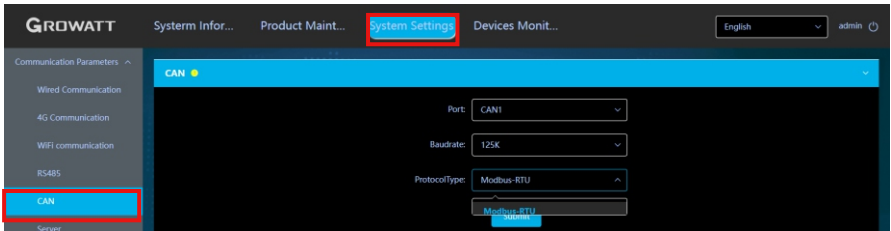

Fig 37 Set the CAN protocol type

(5) After the configuration is complete, select “Submit” . Then it will display “Setting succeeded” .

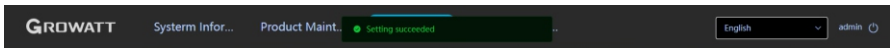



Fig 38 Successful configuration

(6) Verify if the CAN configuration is successful by selecting “CAN” on the left pane under the “System Information” menu.



Fig 39 CAN configuration

## 7.4 Add, delete or query devices for monitoring via ShineMaster-X



NOTE

- You need to add the devices on the “ShineMaster-X datalogger settings” page in order to monitor the PV devices with the ShineMaster-X.
- The ShineMaster-X built-in page will display data related to the devices, including the Inverter” , Meter, Environmental Monitor and PID device. You can also view the historical data.
- Two types of addresses are involved: the device address and the system address. The device address refers to the RS485 communication address of the device; and the system address is assigned by the ShineMaster-X for management. The system address is assigned following sequence that the devices are added, starting from 01.

### 7.4.1 Add or delete a device

#### 1. Add the inverter

(1) Sign in in the built-in page referring to Section 7.1 with the username (admin) and password (admin). Select “Device Monitoring” from the first-level menu > “Inverter” from the second-level menu > “Equipment Maintenance” from the third-level menu.

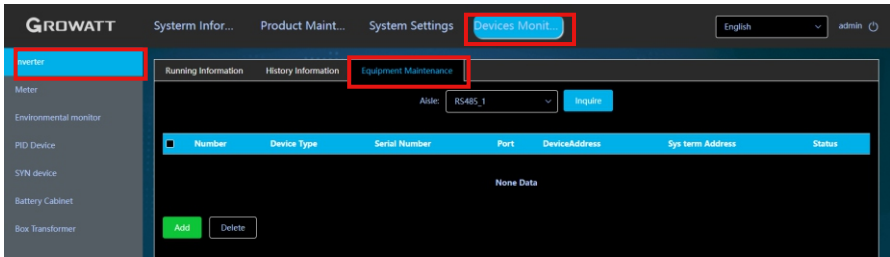
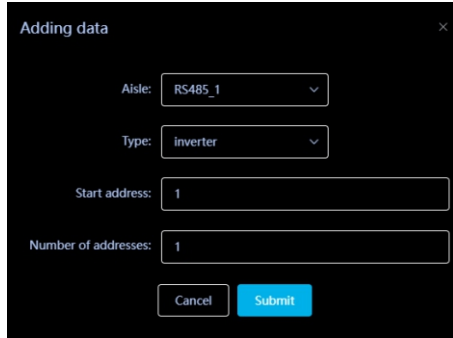

Fig 40 Device Maintenance page of Inverter

(2) Click "Add" , then the "Add data" window will pop up.



Adding data

Aisle: RS485\_1

Type: inverter

Start address: 1

Number of addresses: 1

Cancel Submit

Fig 41 Add the inverter

(3) Select the RS485 route from the "Port" dropdown list, including RS485-1, RS485-2, RS485-3 and RS485-4.



Adding data

Aisle: RS485\_1

Type: RS485\_1  
RS485\_2  
RS485\_3  
RS485\_4

Start address:

Number of addresses: 1

Cancel Submit

Fig 42 Select the RS485 route

(4) Select "Inverter" from the "Type" dropdown list.

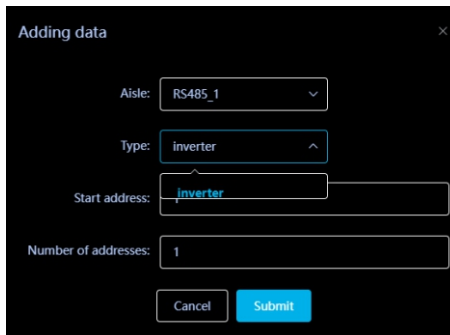

Adding data

Aisle: RS485\_1

Type: inverter

Start address: inverter

Number of addresses: 1

Cancel Submit

Fig 43 Select the device type

(5) Input the device's initial address into the "Start address" field. For instance: if the address of the PV inverter that should be monitored is "1", please set this value to "1".

**Note:**

Up to 12 devices can be added to each RS485 route and the address of the PV device ranges from 1 to 254. PV devices with the same address cannot be connected to the same RS485 route, and only addresses in different routes can be the same.



Fig 44 Start address

(6) Number of addresses: ShineMaster supports adding multiple devices of the same type with consecutive addresses at one time. For example, for the four PV inverters to be monitored with the addresses 1, 2, 3 and 4, set "Start Address" to "1", and "Number of Addresses" to "4".

**Note:**

Up to 12 devices can be added to each RS485 route. If the address starts from 1, a maximum of 12 devices with consecutive addresses can be added at one time.



Fig 45 Number of addresses

(7) Upon submission, the "Setting succeeded" message will be displayed. Then verify if the inverter has been successfully added by choosing "System Information" from the first-level menu > "Device List" from the second-level menu.

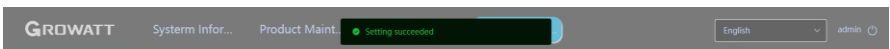

Fig 46 Setting succeeded

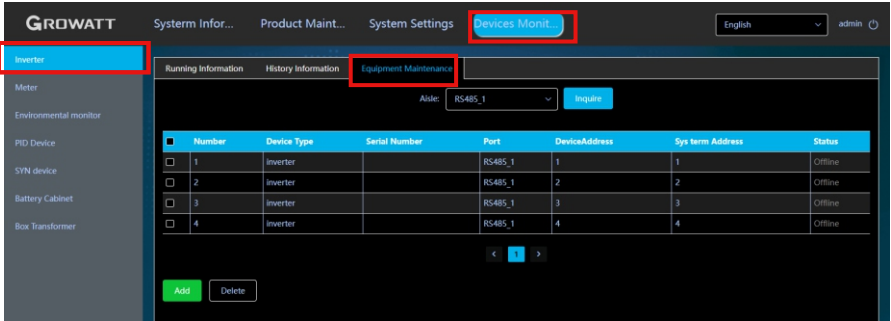

Fig 47 Check the device list

## 2. Add the meter

(1) Sign in the built-in page referring to Section 7.1 with the username (admin) and password (admin). Select “Device Monitoring” from the first-level menu > “Meter” from the second-level menu > “Equipment Maintenance” from the third-level menu.

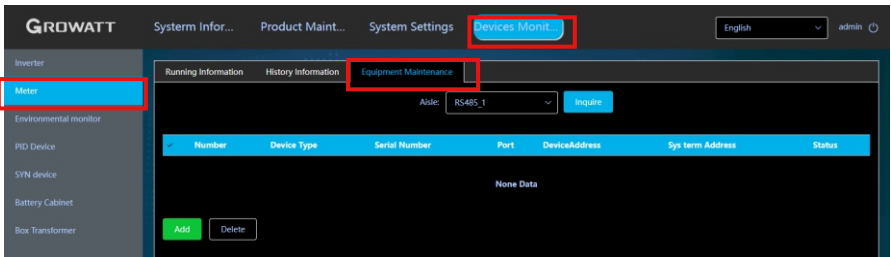

Fig 48 Device Maintenance page of Meter

(2) Click “Add” , then the “Add data” window will pop up.

Fig 49 Add the meter

(3) Select the RS485 route from the “Port” dropdown list, including RS485-1, RS485-2, RS485-3 and RS485-4.



Fig 50 Select the RS485 route

(4) Select the meter type from the “Type” dropdown list, including “Eastron single-phase meter”, “Eastron three-phase meter”, “CHINT single-phase meter”, “CHINT three-phase meter”, “ARREL meter” and “GRT-meter”.

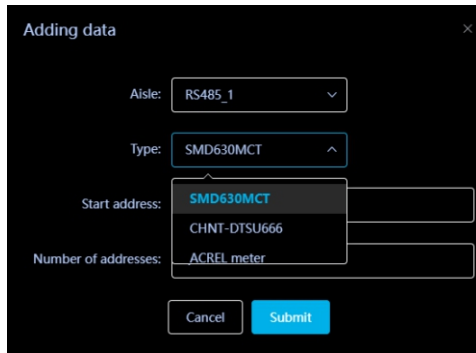

Fig 51 Select the meter type

(5) Input the device's initial address into the “Start address” field. For instance: if the address of the meter that should be monitored is “1”, please set this value to “1”.

**Note:**

Up to 12 devices can be added to each RS485 route and the address of the PV device should be within the range of 1-12.



Fig 52 Start address

(6) Number of addresses: ShineMaster supports adding multiple devices of the same type with consecutive addresses at one time. For example, for the four meters to be monitored with the addresses 1, 2, 3 and 4, set "Start Address" to "1", and "Number of Addresses" to "4".

**Note:**

Up to 12 devices can be added to each RS485 route. If the address starts from 1, a maximum of 12 devices with consecutive addresses can be added at one time.



Fig 53 Number of addresses

(7) Upon submission, the "Setting succeeded" message will be displayed. Then verify if the meter has been successfully added by choosing "System Information" from the first-level menu > "Device List" from the second-level menu.

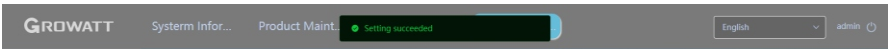

Fig 54 Setting succeed

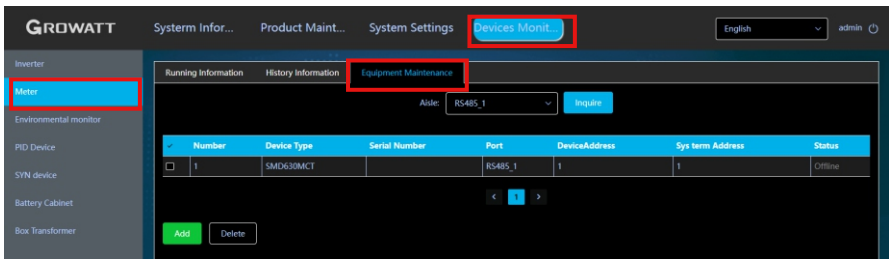

Fig 55 Device List



### 3. Add the environmental monitor

(1) Sign in the built-in page referring to Section 7.1 with the username (admin) and password (admin). Select “Device Monitoring” from the first-level menu > “Environmental monitor” from the second-level menu > “Equipment Maintenance” from the third-level menu.

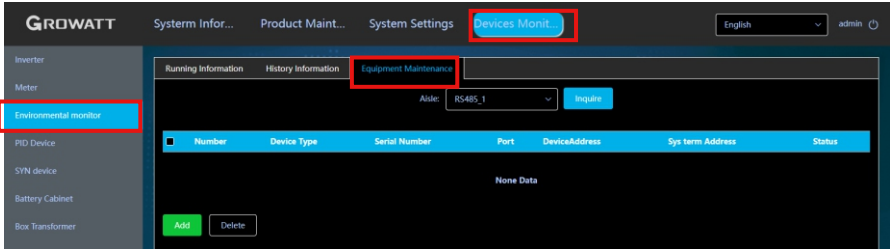

Fig 56 Device Maintenance page of Environmental Monitor

(2) Click “Add” , then the “Add data” window will pop up.

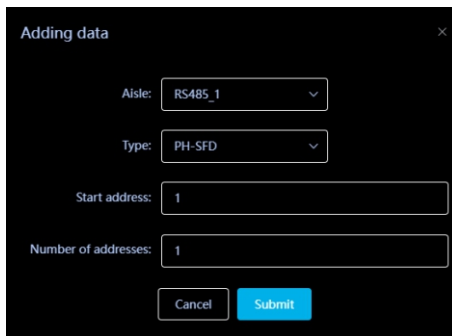

Fig 57 Add the environmental monitor

(3) Select the RS485 route from the “Route” dropdown list, including RS485-1, RS485-2, RS485-3 and RS485-4.

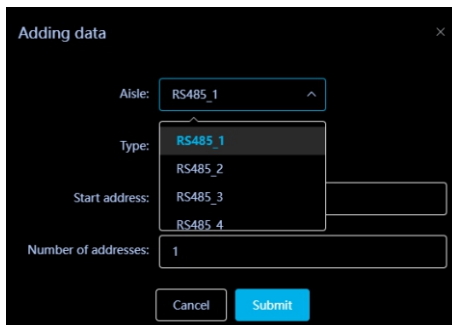

Fig 58 Select the RS485 route

(4) Select the type of the environmental monitor from the "Type" dropdown list.

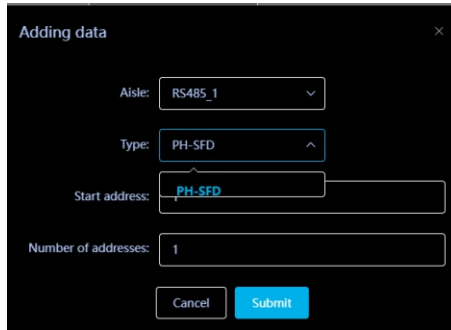

Fig 59 Select the environmental monitor type

(5) Input the device's initial address into the "Start address" field. For instance: if the address of the environmental monitor that should be monitored is "1", please set this value to "1".

**Note:**

Up to 12 devices can be added to each RS485 route and the address of the PV



Fig 60 Start address

(6) Number of addresses: ShineMaster supports adding multiple devices of the same type with consecutive addresses at one time. For example, for the one environmental monitors to be monitored with the addresses 1, set "Start Address" to "1", and "Number of Addresses" to "1".

**Note:**

Up to 12 devices can be added to each RS485 route. If the address starts from 1, a maximum of 12 devices with consecutive addresses can be added at one time.



Fig 61 Number of addresses

(7) Upon submission, the “Setting succeeded” message will be displayed. Then verify if the environmental monitor has been successfully added by choosing “System Information” from the first-level menu > “Device List” from the second-level menu.



Fig 62 Setting succeeded

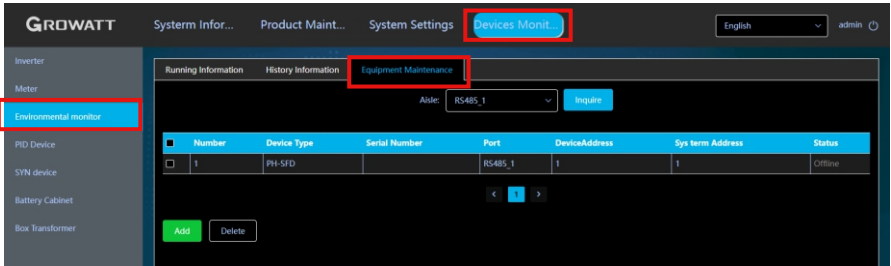

Fig 63 Device list

#### 4. Add the PID device

(1) Sign in the built-in page referring to Section 7.1 with the username (admin) and password (admin). Select “Device Monitoring” from the first-level menu > “PID Device” from the second-level menu > “Equipment Maintenance” from the third-level menu.

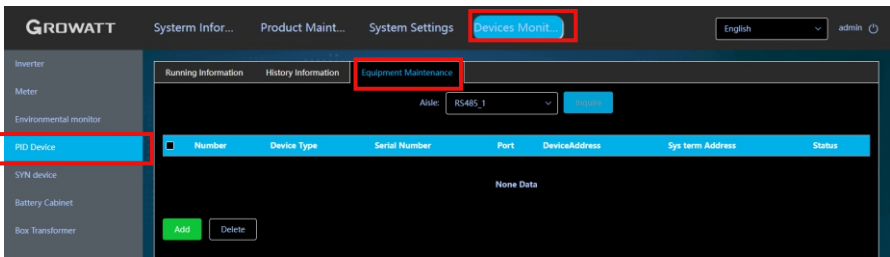
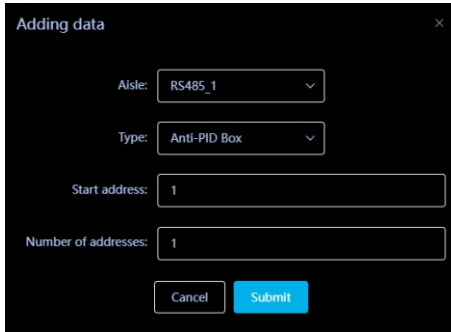

Fig 64 Device Maintenance of PID Device

(2) Click “Add” , then the “Add data” window will pop up.



The screenshot shows a dark-themed window titled "Adding data" with a close button (X) in the top right corner. It contains four input fields: "Aisle:" with a dropdown menu showing "RS485\_1", "Type:" with a dropdown menu showing "Anti-PID Box", "Start address:" with a text input field containing "1", and "Number of addresses:" with a text input field containing "1". At the bottom, there are two buttons: "Cancel" and "Submit".

Fig 65 Add the PID device

(3) Select the RS485 route from the “Route” dropdown list, including RS485-1, RS485-2, RS485-3 and RS485-4.



The screenshot shows the "Adding data" window with the "Type:" dropdown menu open. The dropdown list contains four options: "RS485\_1", "RS485\_2", "RS485\_3", and "RS485\_4". The "Aisle:" dropdown is still set to "RS485\_1". The "Start address:" field is now empty. The "Number of addresses:" field remains set to "1". The "Cancel" and "Submit" buttons are visible at the bottom.

Fig 66 Select the RS485 route

(4) Select the type of the PID device from the “Type” dropdown list.

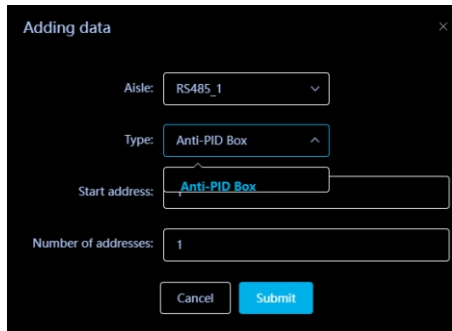

The screenshot shows the "Adding data" window with the "Type:" dropdown menu open. The dropdown list contains one option: "Anti-PID Box". The "Aisle:" dropdown is still set to "RS485\_1". The "Start address:" field is now empty. The "Number of addresses:" field remains set to "1". The "Cancel" and "Submit" buttons are visible at the bottom.

Fig 67 Select the PID device type

(5) Input the device's initial address into the "Start address" filed. For instance: if the address of the PID device that should be monitored is "1" , please set this value to "1" .

**Note:**

Up to 12 devices can be added to each RS485 route and the address of the PV device should be within the range of 1-12.

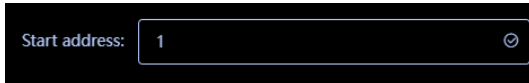

(6) Number of addresses: ShineMaster supports adding multiple devices of the same type with consecutive addresses at one time. For example, for the four PID devices to be monitored with the addresses 1, 2, 3 and 4, set "Start Address" to "1", and "Number of Addresses" to "4".

**Note:**

Up to 12 devices can be added to each RS485 route. If the address starts from 1, a maximum of 12 devices with consecutive addresses can be added at one time.



Fig 69 Number of addresses

(7) Upon submission, the "Setting succeeded" message will be displayed. Then verify if the PID device has been successfully added by choosing "System Information" from the first-level menu > "Device List" from the second-level menu.

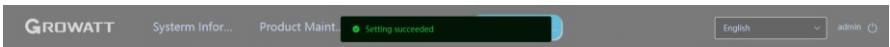

Fig 70 Setting succeed

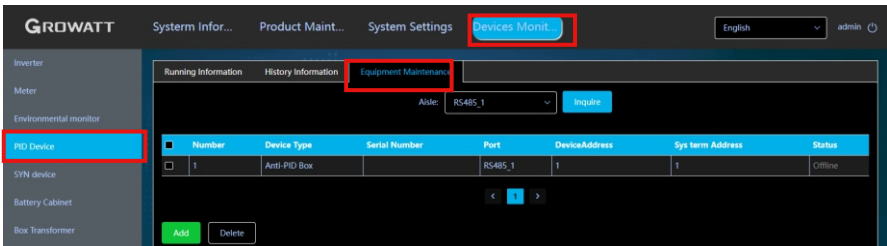

Fig 71 Device list

## 7.4.2 Delete a device

You can delete the device, including the inverter, meter, environmental monitor and PID device. To take the inverter as an example:

(1) Sign in the built-in page referring to Section 7.1 with the username (admin) and password (admin). Select “Device Monitoring” from the first-level menu > “Inverter” from the second-level menu > “Equipment Maintenance” from the third-level menu.

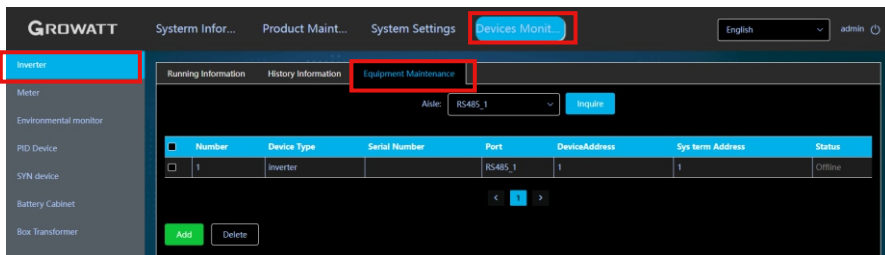

Fig 72 Equipment Maintenance page

(2) Select the PV inverter's RS485 route from the Port dropdown list, then click “Inquire” . The PV device added to the RS485 route will be displayed.

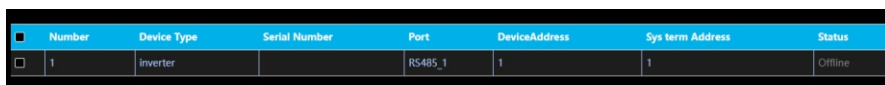

Fig 73 Device list

(3) Tick the checkbox of the target PV device, click “Delete” , then choose “Confirm” .

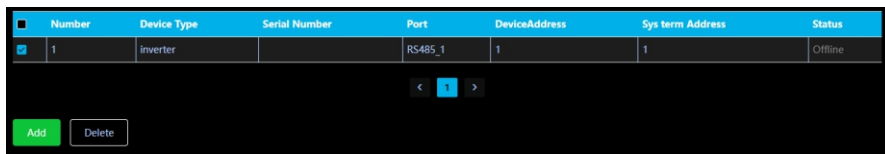

Fig 74 Choose the target device

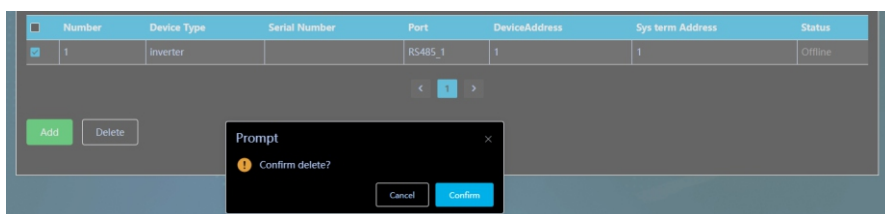

Fig 75 Confirm to delete the device

(4) The “Successfully removed” message will be displayed. Click “Inquire” again to verify that the device has been removed.

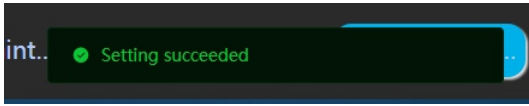

Fig 76 “Successfully removed” pop-up

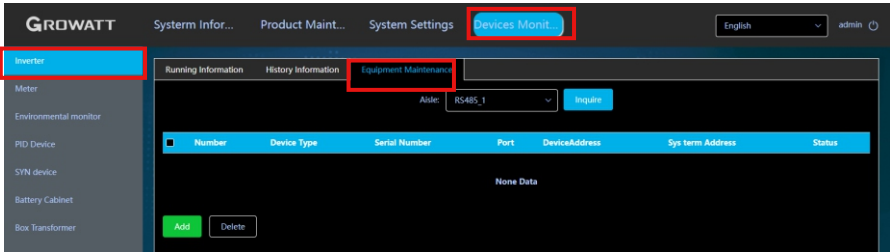

Fig 77 Device list

### 7.4.3 Check the device running information

**Note:**

➤ The ShineMaster-X built-in page will display data related to the devices, including the Inverter, Meter, Environmental Monitor and PID device. You can also view the historical data. The following illustrates the procedure to check device running information, taking the inverter as an example.

(1) Sign in the built-in page referring to Section 7.1 with the username (admin) and password (admin). Select “Device Monitoring” from the first-level menu > “Inverter” from the second-level menu > “Running Information” from the third-level menu.

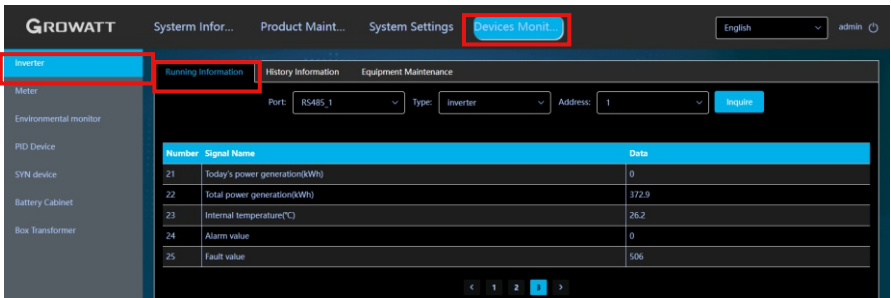

Fig 78 Inverter running information

## 7.5 ShineMaster-X server communication configuration

### 7.5.1 ShineMaster-X network configuration

#### Note:

- The DHCP of ShineMaster-X is disabled by default before delivery. If you select network connection via the router, you need to enable DHCP.
- ShineMaster-X supports connection to the server over wired network or the 4G network.

#### 1. Connect to the server via the router

(1) Firstly, check if the ShineMaster-X's DHCP function has been enabled. Sign in the built-in page referring to Section 7.1.1 with the username (admin) and password (admin), then select Wired Communication on the left pane under the System Settings menu.

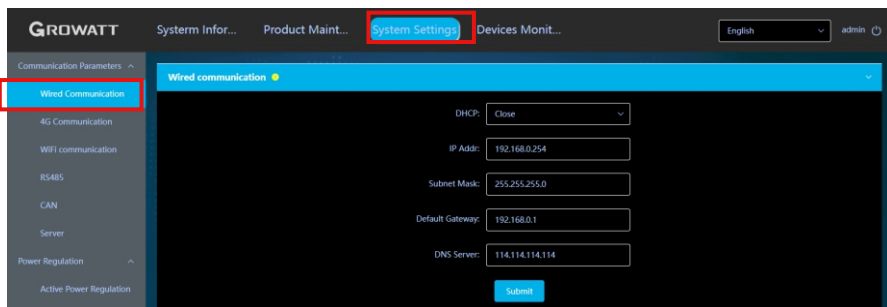

Fig 79 Wired communication settings

(2) The DHCP function is disabled by default, therefore you need to enable the DHCP function to obtain IP address from the router automatically.



Fig 80 Enable the DHCP function

(3) Upon successful configuration, you need to restart the device for the change to take effect.



## 2. Connect to the server via 4G network

(1) Sign in in the built-in page referring to Section 7.1 with the username (admin) and password (admin), then select Wireless Communication on the left pane under the System Settings menu to enable the Network Mode.

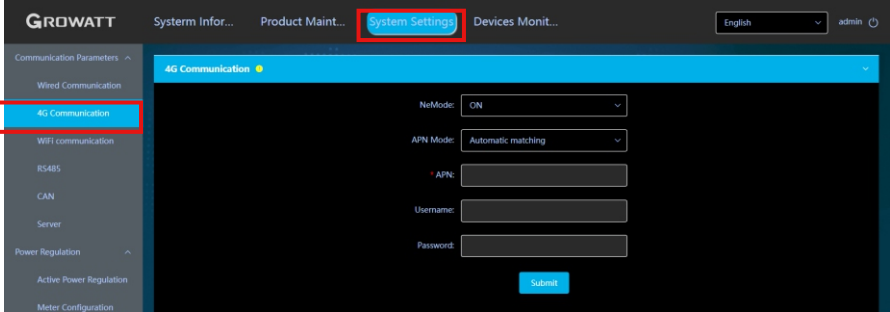

Fig 81 Wireless network settings



Fig 82 Enable the Network Mode

(2) The APN Mode is set to “Auto Match” by default. You can also set this parameter to Manual. You can leave the Username and Password fields blank as they are not mandatory.

(3) Upon successful configuration, you need to restart the device for the change to take effect.

## 3. Parameter settings for using ShineMaster-X with a fixed IP address

(1) Sign in in the built-in page referring to Section 7.1.1 with the username (admin) and password (admin), then select Wired Communication on the left pane under the System Settings menu to disable the DHCP function.

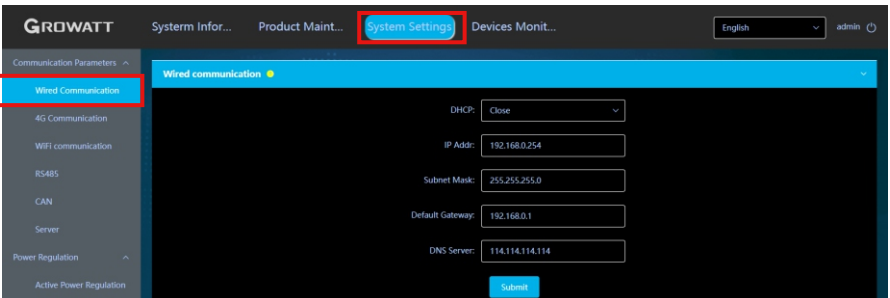

Fig 83 Disable the DHCP function

(2) Input the parameters including the IP Address, Default Gateway, Subnet Mask and DNS Server, then click “Submit” as shown below:

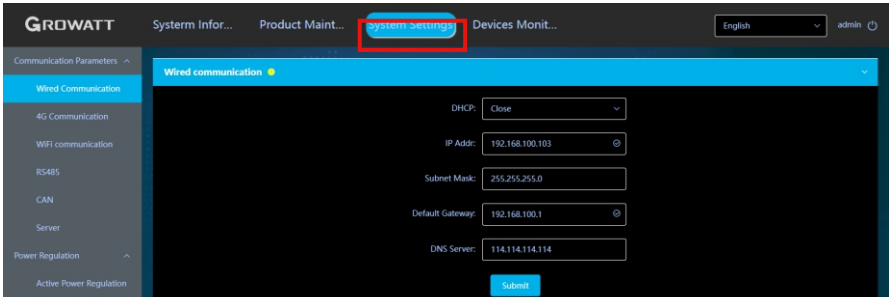

Fig 84 Set the fixed IP address

(3) Upon successful configuration, you need to restart the device for the change to take effect.

### 7.5.2 ShineMaster-X server address settings

Server IP address domain name translation method

(1) Sign in the built-in page referring to Section 7.1 with the username (admin) and password (admin), then select Server on the left pane under the System Settings menu. Select “Enable”, then input the server port number, domain name, e.g. server-cn.growatt.com/server.growatt.com, and the data upload interval.

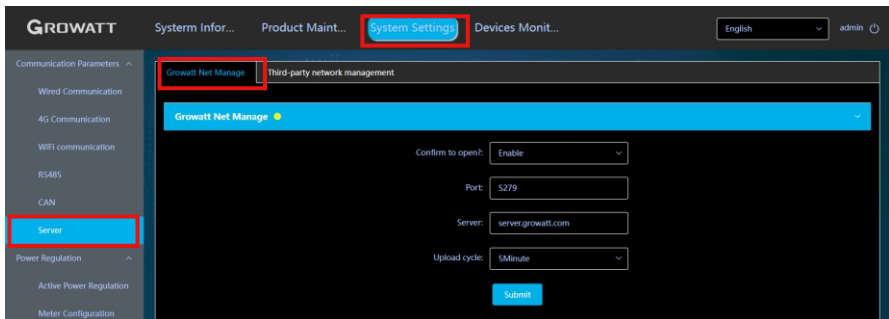

Fig 85 Server configuration

(2) Click “Submit”. The “Setting succeeded” message will be displayed. Verify if the changes are successfully made.

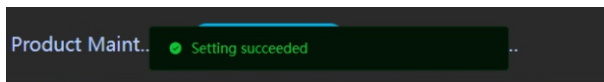

Fig 86 Setting succeeded

(3) Upon successful configuration, you need to restart the device for the change to take effect.

## 7.6 Power adjustment settings

### 7.6.1 Enable active power adjustment

#### Note:

The Export Limitation function is enabled by default. If it is disabled, it will not be able to adjust the power of the PV inverter or the storage inverter, and can only monitor the data.

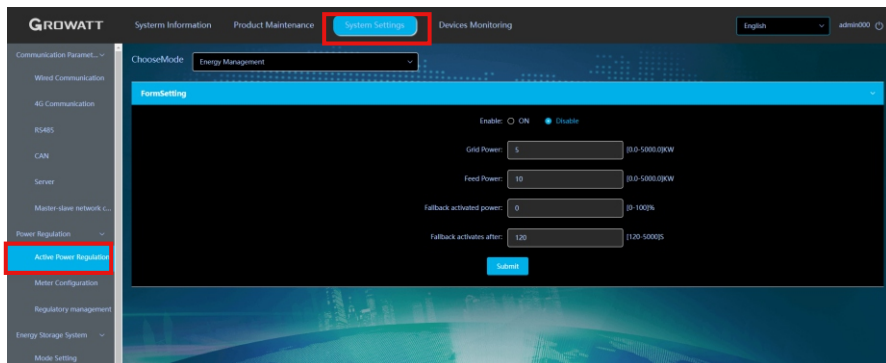

1. Power drawn from the grid: the maximum power allowed to be drawn from the grid (load consumption + battery charging power).
2. Feed-in power: the power allowed to be fed to the grid (only the PV power can be exported to the grid, not the battery power)
3. Fail-safe protection power limit: the power (%) of the PV inverter or storage inverter in case that the power adjustment fails
4. Failure time: time limit within which the communication between the PV inverter, storage inverter and datalogger is disconnected. If the datalogger constantly fails to communication with the PV inverter and storage inverter within this duration, the PV inverter and storage inverter will enter the Failure State.

#### Note:

- The residential storage inverter carries out load compensation during power adjustment. Whenever the load is consuming power, the datalogger will adjust the storage inverter and the PV inverter to perform load compensation, which is not affected by the pre-set value of power drawn from the grid.
- The WIS Commercial and Industrial Storage Inverter mainly compensates the grid power. It carries out grid compensation when the power imported from the grid exceeds the pre-set value.

➤ Two types of Failure State:

- (1) If the communication between the datalogger and the export limitation meter is abnormal, the datalogger will set the PV inverter and storage inverter into the Failure State and operate at the failure power level. This status can only be cleared by the datalogger.
- (2) If the datalogger fails to communicate with the PV inverter and PCS over the failure time, the PV inverter and storage inverter will enter the Failure State and operate at the failure power level. When the communication is re-connected, the PV inverter and storage inverter will exit the Failure State.

### 7.6.2 Meter configuration

Meter Configuration

Enable:

Meter CT: 自定义 0

channel: RS485\_2

MeterType: SDM630MCT

MeterAddr: 2

Submit

1. When the power meter is enabled for power adjustment, the power value of the meter will be read every 100ms.
2. Meter CT: Select the CT configuration of corresponding specifications based on on-site situations (the CT ratio can be customized). If the ShineMaster-X is integrated in the SEM-X, the CT has been configured before delivery, therefore configuration of the CT is not required and the default value is "No" . This is only for the export limitation meter.
3. Port: The default value is RS485-2 for the export limitation meter. You can select the RS485 route based on the actual wiring situation.
4. Meter type and address: Select the corresponding value based on the actual wiring situation. The default address value is 2 for the Eastron three-phase meter; 4 for the CHINT three-phase meter.

### 7.6.3 Adjustment management



This setting item is to set the power adjustment mode:

- Total Phase Adjustment: read Phase A, B and C power of the meter or the total power. Adjust the power of the PV inverter or storage inverter based on the total-phase power and direction.
- Minimum Phase Adjustment: read Phase A, B and C power of the meter. Adjust the power of the PV inverter or storage inverter based on the minimum phase power and direction.
- Single Phase Adjustment: read Phase A, B and C power of the meter. Adjust the power of the PV inverter or storage inverter based on the power and direction of each phase.

#### Note:

- (1) If set to “Disable”, the adjustment mode is “Total Phase Adjustment” by default.
- (2) If all inverters installed on site are PV inverters, you cannot select Single Phase Adjustment. The Single Phase Adjustment function is not available for PV inverters and you can only select Total Phase Adjustment or Minimum Phase Adjustment.

### 7.6.4 Time mode settings

Time mode settings is about defining the working mode of the storage inverter during different time segments. The main working modes are described below:

- Load First: prioritizes supplying power to the loads. Both PV power and battery power can be used for supporting the loads. When importing power from the grid to power the loads, the storage inverter will output corresponding power for compensation. When exporting power to the grid, it should not exceed the Feed-in Power.
- Battery First: prioritizes supplying power to the loads. Both PV power and battery power can be used for supporting the loads. When the load power is less than the permitted power drawn from the grid, it will adjust to charge the battery. Charging power range: load power + battery charging power < permitted power drawn from the grid. In case that the power drawn from the grid exceeds the permitted value, it will reduce the battery charging power. If there is any surplus PV power, it can be fed to the grid, which should not exceed the pre-set feed-in power.

- Grid First: prioritizes supplying power to the loads. Both PV power and battery power can be used for supporting the loads. The surplus power will be fed to the grid, which should not exceed the pre-set feed-in power.
- PV-only storage: prioritizes supplying power to the loads and the battery is not allowed to discharge. The PV power can charge the battery, but the grid power cannot charge the battery. The excess PV power can be fed to the grid. Both PV power and the AC grid power can be used to supply power to the loads. In the off-grid mode, the battery will discharge to power the loads. If the battery energy is not available and an SYN (ATS) is installed, the generator can supply power to the loads.
- Battery Idle Mode: the battery does not charge or discharge power. The PV power is used to support the loads, and the surplus PV power can be fed to the grid. It is allowed to draw power from the grid to power the loads. For backup power during power outage, in the off-grid mode, the PV power and battery power are used to power the loads.
- Standby Mode: the storage inverter does not charge or discharge the battery.

Configure the 9 time windows. Select the appropriate working mode for each time segment based on actual demands.

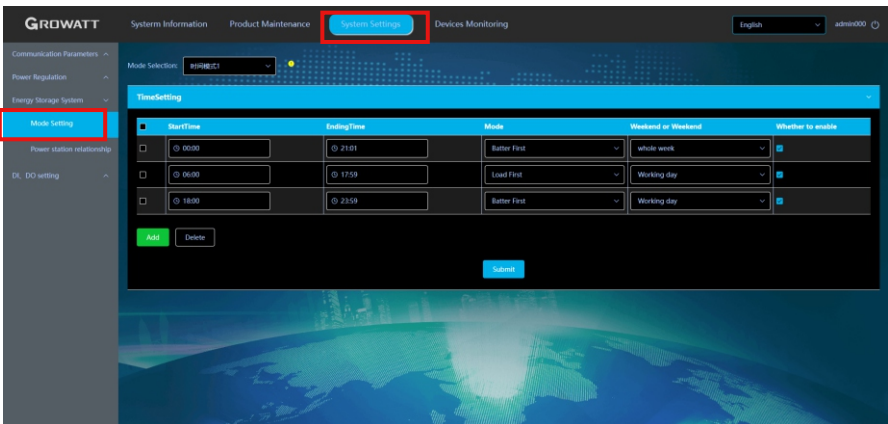

Multiple time mode settings. You can select Special Day 1, Special Day 2, Quarter (1, 2, 3, 4) or Full year, as shown below:

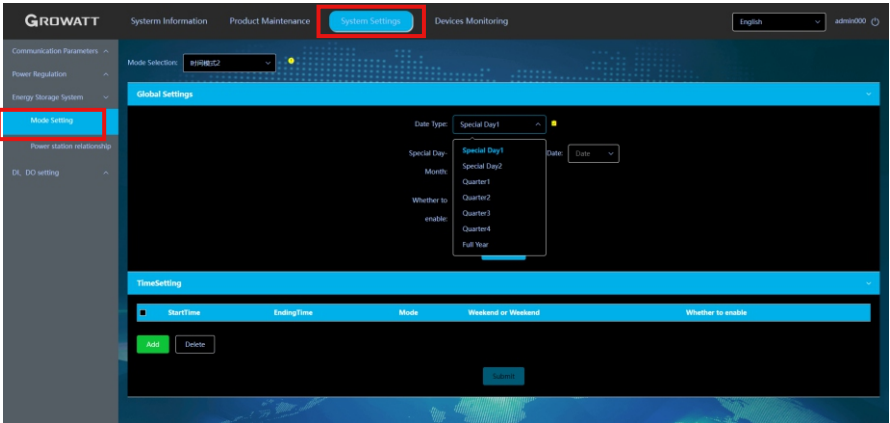

Procedure to set the working mode for idle time is illustrate below:

(1) Add a time segment. When the cursor is on the Start Time (00:00) filed, the "x" icon will be displayed, as the following figure shows.

The image shows a dialog box titled "Adding data" with a close button (X) in the top right corner. It contains several input fields: "StartTime:" with a value of "00:00" and a small circular icon with an 'x' to its left; "EndingTime:" with a value of "23:59" and a similar icon; "Mode:" with a dropdown menu showing "电池优先"; "Weekend or We" with a dropdown menu showing "Working day"; and "ekend:" which is empty. Below these fields is a "Whether to ena" checkbox which is checked, followed by a "ble:" label. At the bottom, there are "Cancel" and "Submit" buttons.

(2) Click the “x” icon, then you can set the working mode for idle time based on the inverter model and on-site situations.

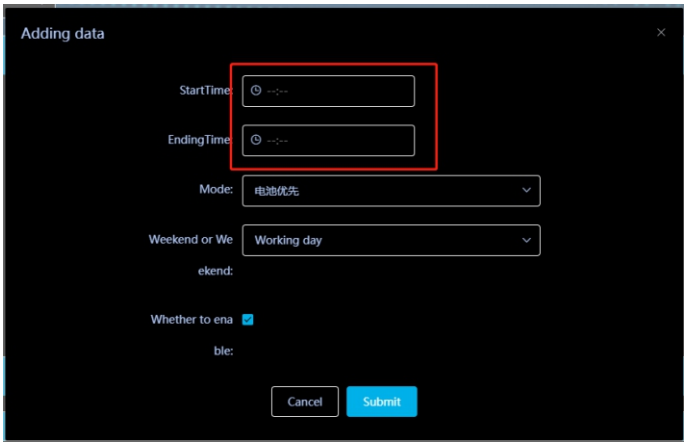

**Note:**

1. During idle time, the working mode is set to Standby Mode by default if not configured. Idle time: all time that has not been configured.
2. Overlapping time segments are not allowed. For instance, if Quarter 1 is selected and the first time segment is set to 8:00 am - 10:00 am, then setting the second time window to 9:00 am - 11:00 am would be invalid. For different time modes, the time segment can be set to the same value. For instance, if one segment is set to 8:00 am - 10:00 am for Special Day 1, setting the time window to 8:00 am - 10:00 am for Special Day 2 would be valid.
3. Priority: Special Day 1 > Special Day 2 > Quarter (1 > 2 > 3 > 4) > Full year

## 7.7 Third-party server configuration

### 7.7.1 Third-party server configuration over MODBUS TCP

**Note:**

1. It is disabled by default.
2. Three options are available: Disable; Enable (limited); Enable (unlimited).  
Disable: Disable connection over MODBUS TCP, prohibiting the third-party management system from connecting to the ShineMaster-X  
Enable (limited): Only the pre-configured client IP addresses are allowed to be connected to the ShineMaster-X server. Less than 3 client IP addresses can be connected and they are configurable.



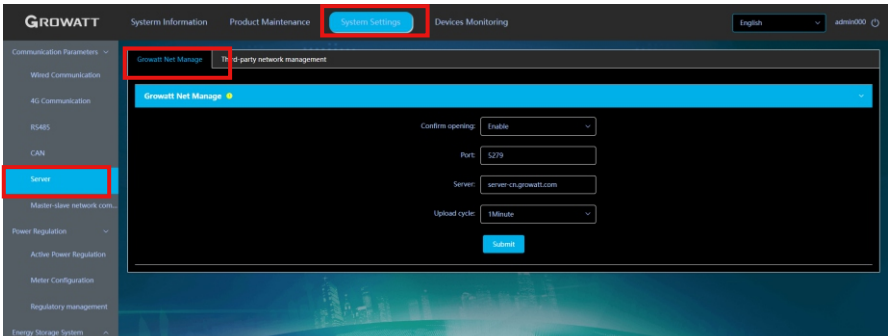

## 7.7.2 Third-party server configuration over IEC104

### Note:

1. It is disabled by default.
2. Three options are available: Disable; Enable (limited); Enable (unlimited).  
 Disable: Disable connection over IEC104, prohibiting the third-party management system from connecting to the ShineMaster-X server.  
 Enable (limited): Only the pre-configured client IP addresses are allowed to connect to the ShineMaster-X server. Less than 3 client IP addresses can be connected and they are configurable.

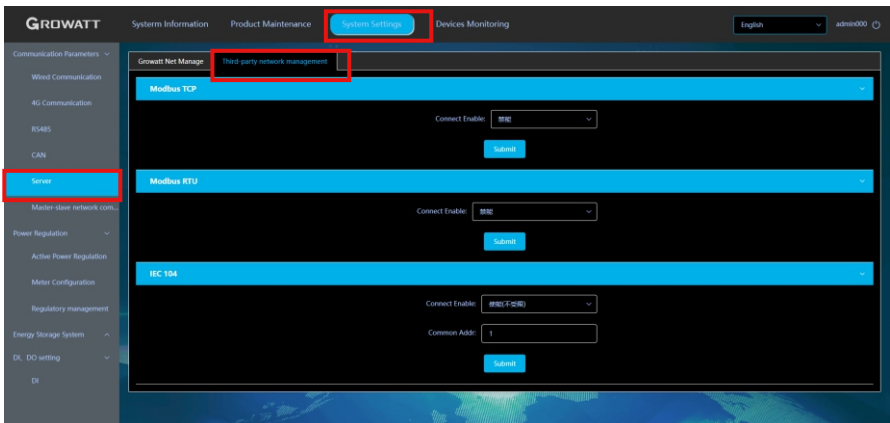

## 7.8 Power plant relationship configuration

### Note:

- All meters involved in the power plant relationship should be on the same node.
1. Configure the relationship according to the relations of the meters connected to the power plant.
  2. After the configuration is complete, click “Submit” to save your settings.

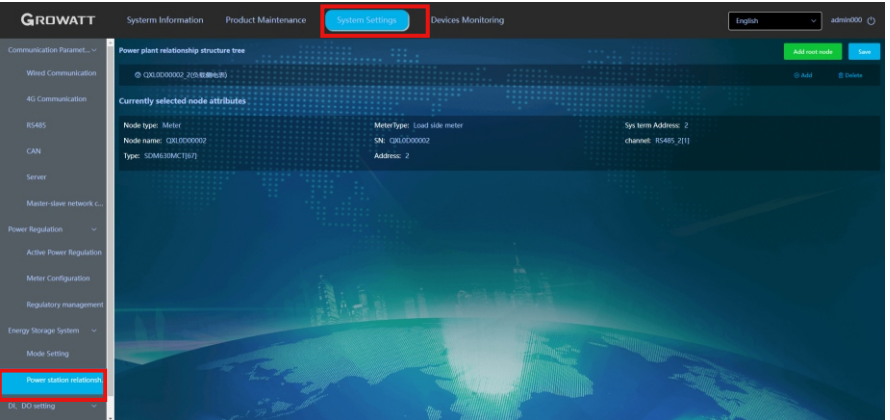
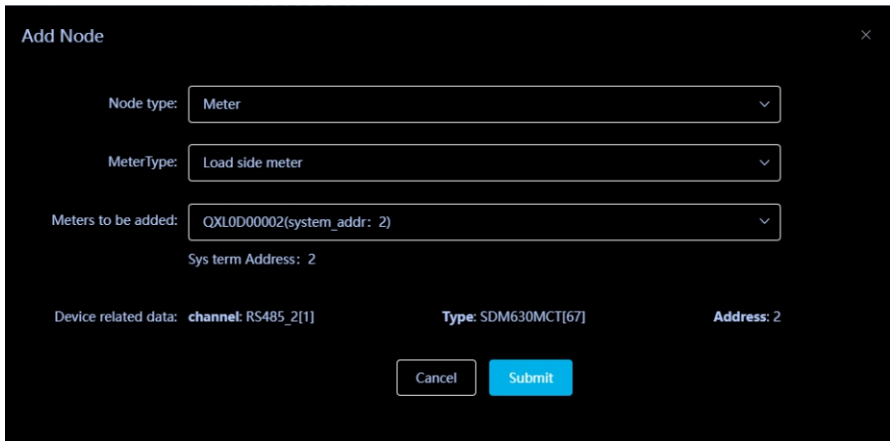
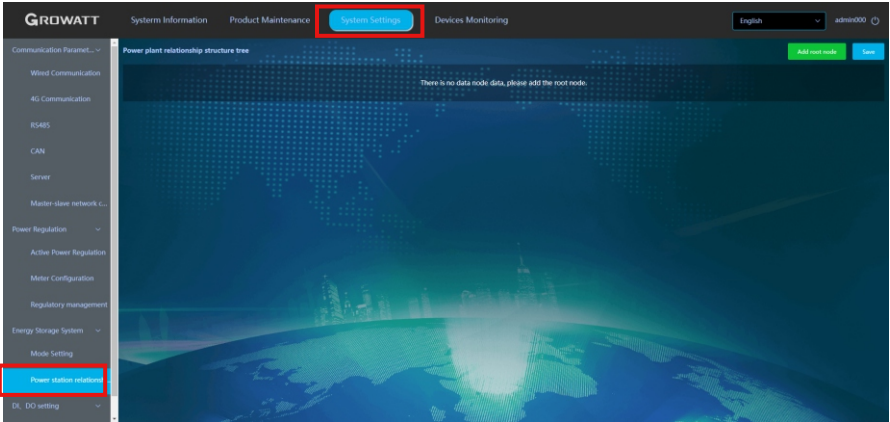

# 8 Technical specifications

## General

Dimensions (W/H/D)	140.0 mm*232.0 mm*40.0 mm
Weight	1.32 kg(+/-0.5kg)
IP rating	IP20

## Operating environment

Operating temperature	-30°C ~ 60°C (-22°F ~ 149°F)
Storage temperature	-40°C ~ 70°C (-40°F ~ 158°F)
Installation location	Indoors

## Communication method

RS485	Max. communication distance: 500 m, up to 48 units can be connected
CAN bus	100K, 250K, 500K

# Contact us 9

If you have technical problems concerning our products, you can contact the local Growatt office or Growatt Support.

Shenzhen Growatt New Energy Co., Ltd.

4-13/F, Building A, Sino-German (Europe) Industrial Park,  
Hangcheng Blvd, Bao'an District, Shenzhen, China

T +86 755 2747 1942

E [service@ginverter.com](mailto:service@ginverter.com)

W [en.growatt.com](http://en.growatt.com)



Download  
Manual



🔍 Growatt New Energy

Shenzhen Growatt New Energy Co., Ltd.

4-13/F, Building A, Sino-German (Europe) Industrial Park,  
Hangcheng Blvd, Bao'an District, Shenzhen, China

T +86 755 2747 1942

E [service@ginverter.com](mailto:service@ginverter.com)

W [en.growatt.com](http://en.growatt.com)

GR-UM-409-A-00 (PN: 044.0102800)